

240 Owner's Manual VOLVO 240 1993 Owner's Manual U.S.A. & Canada

Table of Contents

ESSENTIAL INFORMATION

Please take the time to fill out the forms on this page. When completed, these forms will provide information essential to the proper servicing and ordering of parts for your Volvo.

Owner:

Name: _____

Address: _____

City, State: _____ Zip Code _____

Tel. No. _____

Notice:

Your Volvo is designed to meet all applicable safety and emission standards, as evidenced by the certification labels attached to the door opening sheet metal and on the left wheel housing in the engine compartment. For further information regarding these regulations, please contact your dealer.

Vehicle Information (see "Label information" section)

Vehicle License Number _____

Vehicle Identification Number (VIN) _____

Service Designation Number _____

Engine Designation _____

See "Specifications" section

Color Code _____

Upholstery _____

Tire designation _____

See "Tires" Section

Vehicle Capacity _____

© Volvo Cars of North America

IMPORTANT

You should be familiar with the information in the first two chapters before you operate the car. Information contained in the balance of the manual is extremely useful and should be studied shortly after operating the vehicle for the first time. The manual is structured so that it can be used for reference. It should thus be kept in the car for ready access.

All information, illustrations and specifications contained in this manual are based on the latest product information available at the time of publication. Volvo reserves the right to make model changes at any time, or to change specifications or design, without notice and without incurring obligation. The photograph on the cover shows the international version. 240 B USA,

Table of Contents

[Introduction to the manual ... 2](#)

[Before you drive ... 7](#)

This section provides a detailed description of the vehicle's instruments and controls.

[Reporting safety defects ... 37](#)

[Operating the car ... 53](#)

This section contains items such as starting the engine, operating gear selector, towing trailers.

[Service and maintenance ... 65](#)

An investment which will pay dividends in the form of improved reliability, durability, and resale value.

[Specifications ... 109](#)

All specifications are subject to change without notice. Consult your Volvo dealer for information.

Welcome to the world-wide family of Volvo owners. We trust that you will enjoy many years of safe driving in your Volvo, an automobile designed with your safety and comfort in mind. To ensure your satisfaction with this vehicle, we encourage you to familiarize yourself with the equipment descriptions, operating instructions, and maintenance requirements/recommendations in this manual. We also urge you and your passengers to wear seat belts at all times in this (or any other) automobile. And, of course, please do not operate a vehicle if you may be affected by alcohol, medication, or any impairment that could hinder your ability to drive.

IMPORTANT! (Automatic transmission only)

Your car is equipped with a Shift-Keylock system.

SHIFTLOCK:

When your car is parked, the gear selector is locked in the (P)ark position. To release the selector from this position, turn the ignition key to position II (or start the engine), depress the brake pedal, press the button on the top of the gear selector and move the selector from (P)ark. If it is necessary to manually override the Shiftlock system, see page 107 for instructions.

KEYLOCK:

This means that when you switch off the ignition, the gear selector must be in the (P)ark position before the starting (ignition) key can be removed from the ignition switch.

Your Volvo is designed to meet all applicable safety and emission standards, as evidenced by the certification labels attached to the door opening sheet metal and on the left wheel housing in the engine compartment. For information regarding these regulations, please contact your dealer.



pg. 3 Seatbelts: "Something We Believe In"

Despite our strongest recommendation, and your best intentions, not wearing a seatbelt is like believing "it'll never happen to me!" Volvo urges you and all adult occupants of your car to wear seatbelts and ensure that children are properly restrained, using an infant or booster seat determined by age, weight and height.

Fact: In every state, some type of child-restraint legislation has been passed. Additionally, most states have already made it mandatory for occupants of a car to use seatbelts.

So, urging you to 'buckle up' is not just or recommendation - it's becoming the law! The few seconds it takes to buckle up may one day allow you to say. "It's a good thing I was wearing my seatbelt."

"SOMETHING WE BELIEVE IN"



"SOMETHING WE BELIEVE IN" VOLVO

pg. 4 General Information

Do not export your Volvo to another country before investigating that country's applicable safety and exhaust emission requirements. In some cases it may be difficult or impossible to comply with these requirements. Modifications to the emission control system(s) may render your Volvo non-certifiable for legal operation in the U.S., Canada and other countries.

Model versions of the basic Volvo Models 240.

U.S.A.: Canada:

240 4 -door, wagon 240 4 -door, wagon



pg. 5 Keys

Master Key

This key operates all locks in the vehicle

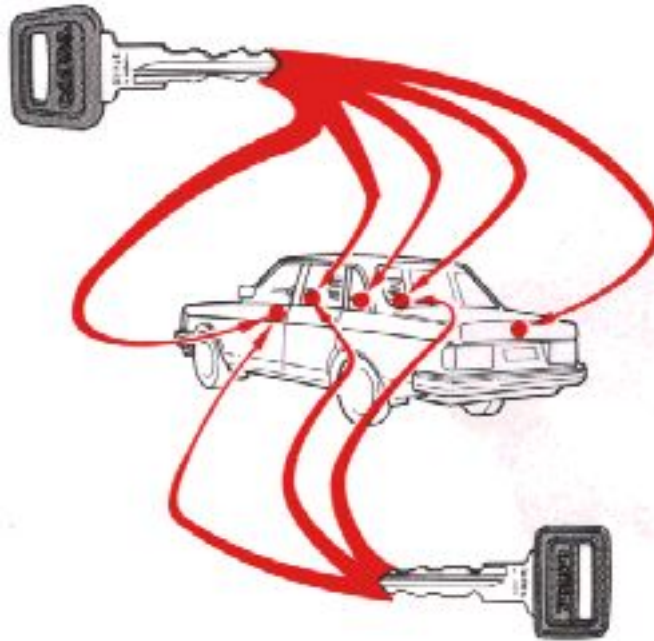

Service key

Front doors

Starting (ignition)/steering wheel lock

The key number codes are stamped on a separate tag supplied with the keys. This tag should be separated from the key ring and kept in a safe place.

The double-sided tape on the back of the tag can be used to secure it safely.

In the event the original keys are lost, duplicates may be ordered from your Volvo dealer.

Number Tag



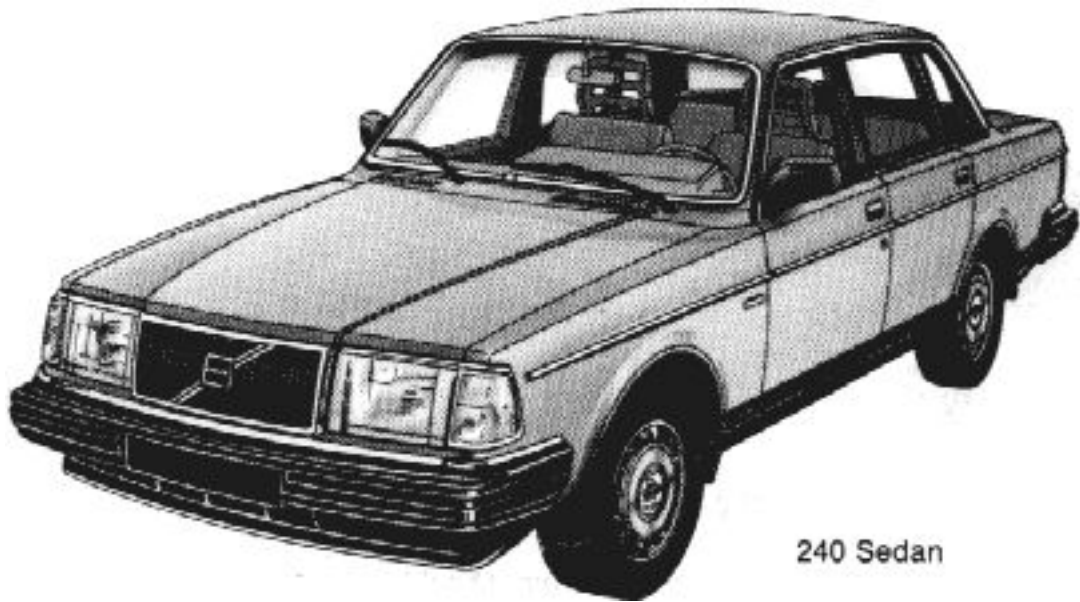

240 Sedan



[Contents](#) | [Top of Page](#)

pg. 104 Service diagnosis

The diagnoses outlined below are intended to serve only as a guide to locate and temporarily correct minor faults. Causes of unsatisfactory performance should be investigated and corrected by your Volvo dealer.

Condition: Starter fails to operate (or operates very slowly)

Possible cause	Correction
Weak battery or dead cell.	With the starting (ignition) switch in the "Driving" or "On" position, check to see if the warning lights on the dashboard come on and if they stay on when the starter is engaged. If the lights do not come on or if they go off when the starter is engaged, the battery is discharged or see below.
Loose or corroded battery cable terminals.	Check battery terminals and clamps. Clean or replace if necessary. Check that the starter cable is secure at its terminals. The ground strap, which connects the battery negative (-) terminal to the engine, should also be checked for corrosion or looseness.
Open circuit between starting (ignition) switch and starting (ignition) switch terminal on starter.	The circuit is closed if a clicking sound is heard from the starter when it is engaged. If no clicking sound is heard, check that the blue wire at the starter is secure. If still no clicking sound is heard, the starting (ignition) switch or the wire is defective.
Starter motor defective.	If the above checks have been performed, and no fault is evident, the starter may be defective. NOTE: In this case the headlight intensity will not dim when the starter is engaged.

pg. 105 Service diagnosis

Condition: Starter motor operates but engine does not start

Possible cause	Correction
Intake system leaking.	Check vacuum hose connections at manifold and auxiliary air valve.

No fuel reaching engine.	Check for fuel in the tank. Check fuse No 4.
No spark	Check that the high tension lead from the coil to the distributor cap is connected and that the wires to the distributor and coil are connected. Check the fuse for the engine control system. The fuse is located in the engine compartment on the left wheel housing by the ignition coil.
Spark plugs, high tension leads or distributor cap wet or defective.	Clean the parts with a dry cloth or spray with a moisture remover. Replace defective or worn parts. If no fault is found following the above steps, contact your Volvo dealer.

Condition: Erratic idle (misfiring)

Possible cause	Correction
Intake system leaking.	Check hose connections.
Spark plugs, high tension leads or distributor cap worn (defective)	Clean distributor cap and leads, check the cap for cracks. Replace defective or worn parts.
Worn spark plugs.	Remove. Clean or replace spark plugs.

pg. 106 Service diagnosis

Condition: Engine stalls at irregular intervals

Possible cause	Correction
Defective wires.	Check wire terminals at: fuel pump, fuse No. 5 and 7, coil, distributor, ignition switch and relays.
Intake system leaking.	Check vacuum hose connections at manifold and auxiliary air valve.
Fuel filter clogged.	Clean fuel tank filter and replace line fuel filter.

Condition: Excessive fuel consumption

Possible cause	Correction
Fuel lines leaking.	Check tightness.
Spark plugs worn.	Replace plugs.

Condition: Misfiring at highway driving speed

Possible cause	Correction
Spark plugs fouled.	Drive the vehicle in a lower gear and keep the engine rpm higher for a few miles in order to remove carbon deposit on the spark plugs. If this procedure is not effective, clean or replace the spark plugs.
pg. 107 Service diagnosis	

Condition: The gear selector can not be moved from the P position

The gear selector is locked in the P position. To release the selector, the ignition must be switched on (ignition key in position II) and the brake pedal must be depressed.

- Depress the brake pedal
- Select a gear
- Release the brake pedal

If the gear selector cannot be moved, check fuses 7 and 12.

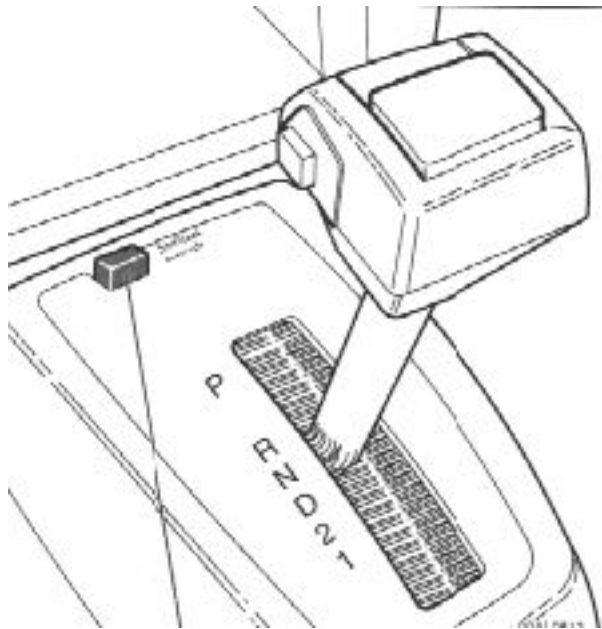

Shiftlock release (automatic transmission only)

The gear selector is locked in the P position. To manually release the shift lock, turn the starting (ignition) key to position I and press firmly on the "SHIFTLOCK OVERRIDE" button located near the base of the gear selector (see illustration). While holding the override button down, move the gear selector from the (P)ark position.

pg. 108 Label information

The Vehicle Identification Number should always be quoted in all correspondence concerning your vehicle with the dealer and when ordering parts.

1 Vehicle Identification Number (VIN)

VIN plate is located on top left surface of dash. The VIN is also stamped on the right hand door pillar.

2 Vehicle Emission Control Information

Your Volvo is designed to meet all applicable safety and emissions standards. Evidence of this can be verified from the certification label on the left wheel valance. For further information regarding these regulations, please consult your Volvo dealer.

3 Model Plate

Vehicle Identification Number (VIN). Codes for color and upholstery etc. This plate is located on right wheel valance.

4 Loads, Capacities, and Tire Pressures

5 Federal Motor Vehicle Safety Standards

(FMVSS) specifications (USA) and Ministry of Transport (CMVSS) Standards (Canada)
Your Volvo is designed to meet all applicable safety standards. Evidence of this can be verified from the certification label on the rear facing side of the driver's front door.

For further information regarding these regulations, please consult your Volvo dealer.

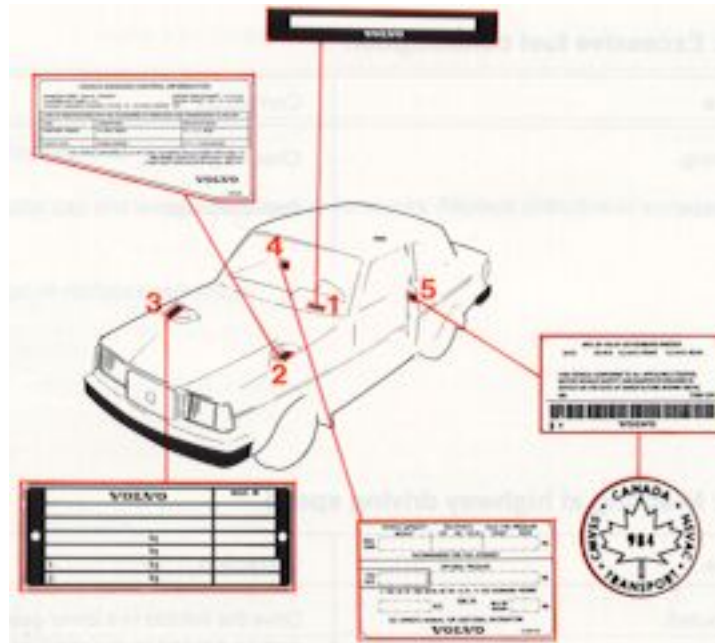

[Contents](#) | [Top of Page](#)

pg. 109 Specifications

<u>Subject</u>	<u>Page No.</u>
Dimensions and weights	110
Cargo space	110
Engine	111
Cooling system	112
Fuel system	112
Ignition system	112
Power transmission	113
Front suspension	113
Capacities	114
Electrical system	114

pg. 110 Specifications

Dimensions and weights for US models	Sedan	Wagon
Length	189.9" (482 cm)	190.7" (484 cm)
Width	67.3" (171 cm)	67.3" (171 cm)
Height, curb weight	56.3" (143 cm)	57.5" (146 cm)
Wheelbase	104.3" (265 cm)	104.3" (265 cm)
Ground clearance (full load)	4.7" (12 cm)	4.7" (12 cm)
Track, front rear	56.3" (143 cm) 53.5"(136cm)	56.3" (143 cm) 53.5"(136cm)
Turning circle (between curbs)	32.2' (9.8 m)	32.2' (9.8 m)
Curb weight (depending on type)	2941-3015 lbs (1335-1369 kg)	3068-3115 lbs (1393-1413 kg)
Gross vehicle weight (GVW)	4030 lbs (1830 kg)	4300 lbs (1950 kg)
Capacity weight	935 lbs (424 kg)	1180 lbs (536 kg)
Permissible axle weight, front rear	1885 lbs (855 kg) 2180 lbs (990 kg)	1885 lbs (855 kg) 2600 lbs (1180 kg)
Max. trailer weight (w/o brakes)	1540 lbs (700 kg)	1540 lbs (700 kg)
Max. trailer weight (with brakes - 2" ball)	3300 lbs (1500 kg)	3300 lbs (1500 kg)

Max. trailer weight (with brakes - 1 7/8" ball))	2000 lbs (900 kg)	2000 lbs (900 kg)
Max. hitch load	165 lbs (75 kg)	165 lbs (75 kg)

Cargo Space	Wagon models
Length with rear seat up	44.5" (113 cm)
Length with rear seat down	74.0" (188 cm)
Length with seat cushion removed	77.6" (197 cm)
Maximum width	53.1" (135 cm)
Height	32.9" (84 cm)
Volume with rear seat up	41 cu. ft. (1.2 m ³)
Volume with rear seat down	76 cu. ft. (2.151 m ³)
Cargo opening, maximum width	45.7" (116 cm)
Cargo opening, maximum height	30.7" (78 cm)

WARNING: When adding accessories, equipment, luggage and other cargo to your vehicle, the total loaded weight capacity of the vehicle must not be exceeded. Consult your dealer for information.

Dimensions and weights for Canadian models		
	Sedan	Wagon
Length	482 cm	484 cm
Curb weight (depending on type)	1316-1346 kg	1371- 1391 kg
Gross vehicle weight	1830 kg	1950 kg
Capacity weight	425 kg	535 kg
Permissible axle weight, front rear	855 kg 990 kg	855 kg 1180 kg

pg. 111 Specifications

Engine B230F (2.3 liters; 141 cu. in.)

Liquid-cooled, gasoline, 4-cylinder in-line engine. Cast-iron cylinder block with cylinders bored directly

in block. Aluminum-alloy cylinder head with single overhead camshaft and separate intake and outlet channels. Engine lubrication is provided by a gear pump driven from the crankshaft. Full-flow type oil filter. Exhaust-emission control accomplished by fuel injection, Lambda-sond system and catalytic converter.

Output (SAE J1349)	114 hp at 5400 rpm (85 kW at 90 rps)	
Max. torque (SAE J1349)	136 ft. lbs. (185 Nm) at 2700 rpm	
Number of cylinders	4	
Bore	3.78" (96 mm)	
Stroke	3.15" (80 mm)	
Displacement	2.32 liters (141 cu. in.)	
Compression ratio	9.8:1	
Valve clearance, cold engine inlet and exhaust	Checking: 0.012-0.016" (0.30-0.40 mm)	Adjusting: 0.014-0.016" (0.35-0.40 mm)
Valve clearance, warm engine inlet and exhaust	0.014-0.018" (0.35-0.45 mm)	0.016-0.018" (0.40-0.45 mm)

All specifications are subject to change without notice.

pg. 112 Specifications

Engine B230F

Cooling System

Type Positive pressure, closed system

Thermostat begins to open at 188,6 ° F (92 ° C)

Fan belts, designation HC-38 x 918 (two)

A/C belt, designation HC-38x850

Coolant: Volvo Original coolant/antifreeze

Fuel system

The engine is equipped with an electronic fuel injection system.

Ignition System

Firing order 1-3-4-2

Ignition setting (12 ° B.T.D.C. at 750 rpm)

Spark plugs Bosch WR7DC (or equivalent)

Spark plug gap 0.028-0.032" (0.7-0.8 mm)

Tightening torque 15-22 ft. lbs. (20-30 Nm)

Distributor, direction of rotation Clockwise

pg. 113 Specifications

POWER TRANSMISSION

Manual or automatic transmission. Hypoid type final drive.

Manual transmission M47 II

Reduction ratios:

1st gear 4.03:1

2nd gear 2.16:1

3rd gear 1.37:1 Rear axle reduction ratio:

4th gear 1.00:1 3.31:1

5th gear 0.80:1

Reverse 3.68:1

Automatic transmission AW70

Reduction ratios:

1st gear 2.45:1

2nd gear 1.45:1 Rear axle reduction ratio:

3rd gear 1:1 3.73:1

Overdrive 0.69:1

Reverse 2.22:1

Vehicle speed/1000 engine rpm (manual transmission)

Rear axle ratio 3.31:1

mph km/h

1st gear 5.4 8.7

2nd gear 10.0 16.2

3rd gear 15.8 25.5

4th gear 21.7 34.9

5th gear 26.4 42.5

Reverse 5.9 9.5

Front suspension

McPherson type spring and strut suspension. Shock absorbers housed in strut casing. Rack and pinion steering.

Safety-type steering column.

The alignment specifications apply to an unloaded car but include fuel, coolant and spare wheel.

Toe-in, measured on the wheel rim: $1/16" \pm 3/64"$ (1.5 ± 1.0 mm)

Camber (not to exceed $1/2^\circ$ difference between sides):

- All $+1/4^\circ$ to $+3/4^\circ$

(Reduce camber if excessive wear on tire outer shoulder is observed)

Caster: not adjustable



[Contents](#) | [Top of Page](#)

Capacities

Fuel tank	15.8 US gals	60 liters
Cooling system		
-manual transmission	9.9 US qts	9.4 liters
-automatic transmission	9.7 US qts	9.2 liters
-expansion tank separately	0.7 US qts	0.6 liters
Engine:		
-oil and filter change	4.0 US qts	3.85 liters
-oil changed separately	3.5 US qts	3.35 liters
Transmission:		
-manual, M47 II	1.6 US qts	1.5 liters
-automatic, AW70	7.8 US qts	7.4 liters
Rear axle -1031	1.7 US qts	1.6 liters
Power steering gear	0.8 US qts	0.75 liters
Windshield washer fluid	3.4 US qts	3.2 liters

ELECTRICAL SYSTEM

12 V, negative ground. Voltage-controlled alternator.
Single-wire system with chassis and engine used as conductors.

Voltage 12 V

Battery:

-capacity 445 A/85 min

Alternator:

-rated output 1120W, 80A with AC

Lights, 12 V	US bulb No.	Power	Socket	No. of bulbs

Headlights	HBI/9004	45 W/65 W		2
Position lights, front	1157NA	21 W/24 cp 5 W/2.2 cp	BaY 15d	2
Turn signals, front	1157NA	21 W/24 cp 5 W/2.2 cp	BaY 15d	2
Turn signals, rear	1156	21 W/32 cp	Ba 15 s	2
Brake light/ tail light	1157	21 W/31 cp 5 W/3 cp	BaY 15d	2
High-mounted brake light	1156	21 W/32 cp	Ba 15 s	1
Back-up lights	1156	21 W/32 cp	Ba 15 s	2
Rear fog lights	1156	21 W/32 cp	Ba 15 s	2

The following bulbs may be obtained from your nearest Volvo dealer:

Rear ash tray light		1.2 W	W2x4.6d	1
License plate light, sedan		4 W	Ba 9 s	2
License plate light, wagon		5 W	S 8.5-8	2
Interior light		10 W	S 8.5-8	1
Glove box light		2 W	Ba 9 s	1
Instrument panel light		3 W	W2.1x9.5d	2
Control panel light		1.2 W	W2x4.6d	3
Shift positions, auto trans.		1.2 W	W2x4.6d	1
Trunk light		15 W	S 8.5-8	1
Warning indicator lamps				
Charging		1.2 W	W2x4.6d	1
Turn signals		1.2 W	W2x4.6d	2
Brake failure		1.2 W	W2x4.6d	1
Parking brake		1.2 W	W2x4.6d	1

Headlights		1.2 W	W2x4.6d	1
Oil pressure		1.2 W	W2x4.6d	1
Overdrive off (auto trans.)		1.2 W	W2x4.6d	1
Warning flashers		1.2 W	W2x4.6d	1
El. heated window		1.2 W	W2x4.6d	1
Seat belts		2 W	Ba 9 s	2
Bulb failure		1.2 W	W2x4.6d	1

pg. 115 Specifications

Recommended max. and min. speeds*, mph (km/h)

Manual transmission M47 II

1st gear	2nd gear	3rd gear	4th gear	5th gear
-25 (-40)	10-44 (20-70)	20-70 (30-110)	25-(44-)	44-(70-)

* always observe posted speed limits.

Vehicle Loading

The tires on your Volvo will perform to specifications at all normal loads when inflated as recommended on the tire information label located on the rear facing side of the right front door. This label lists both tire and vehicle design limits.

Do not load your car beyond the load limits indicated.

See Consumer Information Booklet for complete tire pressure information.

Sample Tire Pressure Label

VEHICLE CAPACITY		OCCUPANTS		COLD TIRE PRESSURE		
WEIGHT		FRT	RR	TOTAL	FRONT	REAR
MAX LOAD		2	3	5		PSI
RECOMMENDED FOR FUEL ECONOMY						
OPTIONAL PRESSURE						
TIRE SIZE		2	1	3		PSI
IF TIRES ARE NOT TIRED SAYING ARE MPD (28 MPa) TO THESE RECOMMENDED PRESSURES						
	SIZE	SPARE TIRE	WELLING PRESSURE			PSI
SEE OWNER'S MANUAL FOR ADDITIONAL INFORMATION						
VOLVO						
1326144						

Car model	US		CDN	
	Tire	Wheel rim	Tire	Wheel rim
Sedan	185/70R	5,5x14"	185/70r	5,5X14"
Wagon	185R14	5,5x14"	185R14	5,5x14"
Special spare	5x15"		5x15"	

pg. 116 Volvo Service Manuals

Service Manuals for your Volvo are available for purchase. These are the same used by competent Volvo technicians.

Major sections within the binder system include: 0-General Information; 1-Service and Maintenance; 2-Engine; 3-Electrical System and Instruments; 4-Power Transmission; 5-Brakes; 6-Suspension and Steering; 7-Frame, Springs, Dampers and Wheels; 8-Body.

A Service Manual Brochure/Order Form was placed in the car prior to delivery from the dealer to you. Complete ordering information is provided.



Volvo supports Voluntary Mechanic Certification by the N.I.A.S.E. Certified mechanics have demonstrated a high degree of competence in specific areas.

Besides passing exams each mechanic must also have worked in the field for two or more years before a certificate is issued.

These professional mechanics are fully able to analyze vehicle problems and perform the necessary service procedures to keep your Volvo at peak operating condition.

Note! The above pertains to USA only.

pg. 117 Road assistance



Your new Volvo comes with a three year road assistance program known as ON-CALL. Additional information, features, and benefits are described in a separate information package in your glove compartment.

If you have misplaced you package, dial 1-800-63 VOLVO (8-6586) for assistance.

Inside back cover

WARNING!

Detergents and solvents

Do not use gasoline containing lead or benzene as a detergent or solvent. Both lead and benzene are toxic and may be hazardous to your health.

WARNING!

Carbon monoxide is a poisonous colorless and odorless gas which is present in all exhaust gases. If you ever smell exhaust fumes inside the vehicle, make sure the passenger compartment is ventilated and immediately return the vehicle to dealer for correction.

Never sit in a parked or stopped car for any extended amount of time, nor have it unattended while engine is running.

Never operate the engine in confined, unventilated areas.

WARNING!

Installation of optional equipment/use of mobile telephones

Incorrectly installed optional equipment, alarm systems or the use of mobile telephones which are not connected to a suitable antenna can cause faults in the car's electronic control systems. Consult your Volvo dealer before installing any such products.

Back cover



Oil level between dipstick marks. The distance between the marks represents approx. 1 US qt. = 1 liter. Fill with multigrade oil

Check without removing the cap that the brake fluid level is above the Min-mark. Brake and clutch fluid DOT 4 or 4+.

Coolant level between the expansion tank marks. Mixture: 50 percent anti-freeze and 50 percent water.

Washer fluid reservoir should be filled with water and solvent (wintertime: windshield washer anti-freeze).

Electrolyte level 1/4" - 3/8" (5 - 10 mm) above plates. Fill distilled water only, never acid. Check level in conjunction with normal service or once a year. Never operate engine in closed unventilated areas.

Changing a wheel, see pages 96, 97
a bulb, see pages 88-92
a fuse, see page 93

Fuel: Octane rating 95 RON Unleaded, 91 (R+M)/2
Min. 91 RON Unleaded, 87 (R+M)/2

WARNING!

The cooling fan may start or continue to operate (for up to 6 minutes) after the engine has been switched off.

VOLVO
Volvo Car Corporation
Goteborg, Sweden
TP3398/1 (Canada & U.S.A.) 20 000.7.92. Printed in Sweden. ELANDERS TRYCKERI,



[Contents](#) | [Top of Page](#)

Starting (ignition switch)

Starting (ignition) switch/steering wheel lock



O Locked position: remove the key to lock the steering wheel.



I Intermediate position: certain circuits (heater blower, cigarette lighter, accessories, etc.) on.



II Drive position: key position when engine is running.



III Starting position: release the key when engine starts. The key returns automatically to drive position.

WARNING:

Never turn the key to position 0 while driving or when the car is being towed.

* On cars equipped with an automatic transmission the gear selector must also be in the (P) park position.

The steering wheel lock may be under tension when the car is parked. Turn the steering wheel slightly to free the ignition key.

A chime will sound if the starting key is in the ignition lock and the front door on the driver's side is open. The chime will also sound if the parking lights are on when the door is open. The chime goes off when the front door is closed. In order to reduce car theft, make sure the steering wheel lock is engaged before leaving the car.

Turn signals

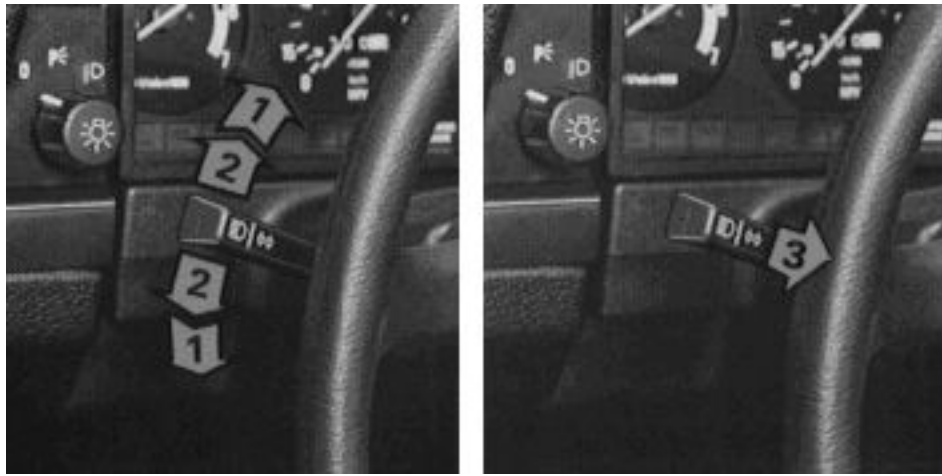



Turn signals

1 Signal lever engaged for normal turns.

Note: A defective turn signal bulb will cause turn signal indicator and remaining signal lights to flash more rapidly than normal.

2 Lane change position. In maneuvers such as lane changing, the driver can flash the turn signals by moving the turn signal lever to the first stop and holding it there. The lever will return to the neutral position when released.

3 High and low beam switching (Headlight switch in position ()). Move the lever towards the steering wheel and release it.

3 Headlight flasher (Headlight switch in position () or (0)). Move the lever towards the steering wheel. The headlight high beam will be on until the lever is released.



Rear fog light

The rear fog light is considerably brighter than the normal tail lights and should be used only when atmospheric conditions, such as fog, rain, snow, smoke or dust reduce the daytime or nighttime visibility of other vehicles to less than 500ft (152 meters). (The headlights must be switched on.)

The fog light is located in the section of the tail light closest to the center of the vehicle. (Driver side only)

Note: Local regulations governing the use of this light may vary.



Lighting

Headlights and position lights

0 All lights off*

 Parking lights on*

 Headlights and parking lights on

Switch from upper to lower beams, and vice versa, by moving the turn signal switch lever on the left side for the steering column towards the steering wheel. The parking lights can be used without switching on the starting (ignition) key.

*Canadian models equipped with daytime running lights: Headlights and parking lights on when starting (ignition) switch is switched on.



A chime will sound if the starting (ignition) key is in the switch lock when the door is open. The chime goes off when the driver's door is closed.

If the headlight switch is in position , all lights will go out when starting (ignition) switch is switched off.

Instrument panel lamps rheostat

Clockwise - brighter

Counterclockwise - dimmer

pg. 16 Windshield wipers, Tailgate window wiper, Washer nozzles

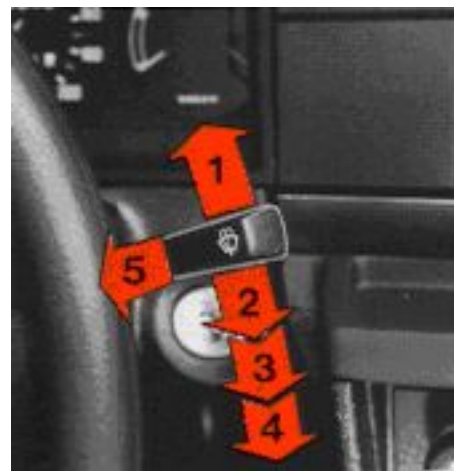

Wiper/washer

1 Intermittent wiper

With switch in this position, the wipers will make a stroke approx. every seventh second.

2. "Single stroke" position

Switch returns automatically when released.

3 Wipers, low speed

4 Wipers, high speed

5 Windshield wiper/washer

The wiper will make 2-3 complete stroking cycles after the lever is released.

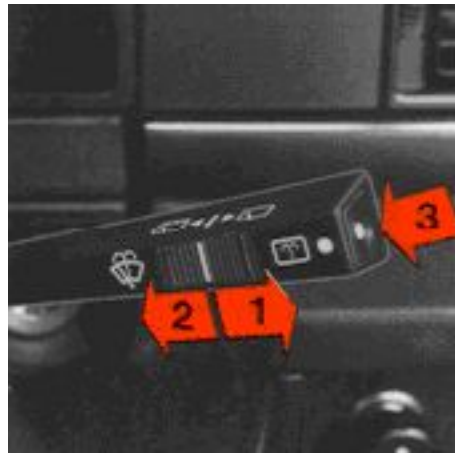

Tailgate window wiper/washer, wagon

Operated by the switch at the end of the windshield wiper/washer operating lever.

1 Tailgate wiper ON

2 Interval position

With the switch in this position, there is one stroking cycle approx. every fifteen seconds.

3 Tailgate washer

Depress the button to start the wiper/washer. The wiper will complete 2-3 stroking cycles after the button is released.

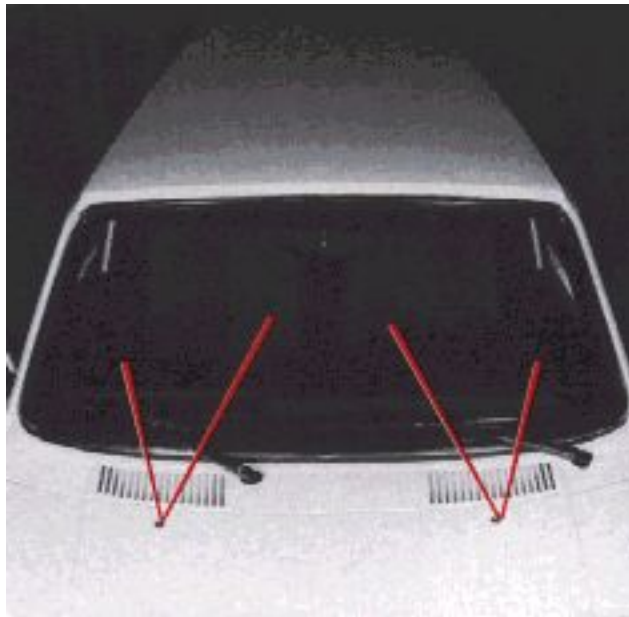

Adjusting washer nozzles

The fluid spray may be adjusted by carefully inserting a needle into the metal nozzle and rotating nozzle to desired position.

pg. 17 Cruise Control

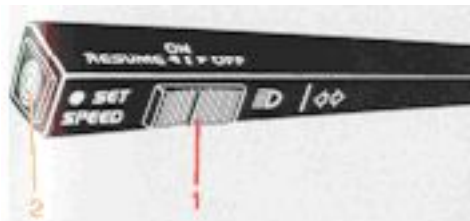

Cruise Control (option)

The cruise control switches are located on the turn signal switch lever.

To engage and set desired speed:

- 1 Set switch (1) to ON.
- 2 Accelerate to desired cruise speed.

NOTE: the cruise control cannot be engaged at speeds below 22 mph (35km).

- 3 Depress SET SPEED switch (2).

Operating brake pedal or clutch pedal (where applicable)

This will automatically disengage the cruise control. Previously selected cruise speed is retained in the memory and by momentarily setting the switch to RESUME position that speed will be re-engaged.

If the cruise control is already engaged, the cruising speed can be increased by depressing the SET SPEED button (2). The vehicle will then maintain the current speed.

If actual speed falls below 70% of set speed or if the wheels spin or lock, the cruise control will disengage automatically.

WARNING!

The cruise control should not be used in heavy traffic or when driving on wet or slippery roads. If the gear shift is moved to Neutral while the cruise control is engaged, then depress the brake pedal momentarily, or set the cruise control switch (1) to OFF. This will disengage the cruise control and prevent overrevving the engine.

NOTE: When driving on a grade, actual vehicle speed may vary slightly from the set cruise control speed. If actual speed falls below 70% of set speed or if the wheels spin, the cruise control will disengage automatically.

Acceleration

Momentary acceleration, such as for passing, does not interrupt cruise control operation. The previously selected speed will be maintained without having to set switch to RESUME.

To disengage the cruise control system:

Set switch (1) to position OFF, or depress brake pedal, or depress clutch pedal (where applicable). Switching off the starting (ignition) switch will automatically disengage the cruise control system.

pg. 18 Washer fluid reservoir, Rear window demister, Hazard warning flasher



Washer fluid reservoir

The washer fluid reservoir for the windshield and tailgate washer (wagon) is located in the engine compartment and holds approx. 0.8 US gals = 3.2 liters. During the wintertime, the reservoir should be filled with anti-freeze washer fluid specified in section titled "Cold Weather Driving".



Rear window demister

To operate depress the switch. The indicator lamp in the switch will come on. The system will be switched off automatically after 10-15 minutes or when the starting (ignition) key is switched off. Do not place items against the inner surface of the rear window that may damage the printed circuit. Do not scrape the inner surface of the rear window glass with a hard object or use an abrasive window cleaner, otherwise damage to the printed circuit will occur.

Hazard warning flasher

The four-way flasher should be used to indicate that the vehicle has become a traffic hazard.

Note: Regulations regarding to the use of the hazard warning flasher may vary from state to state.

pg. 19 Heated door mirrors, Parking brake, Seat heaters (certain models)

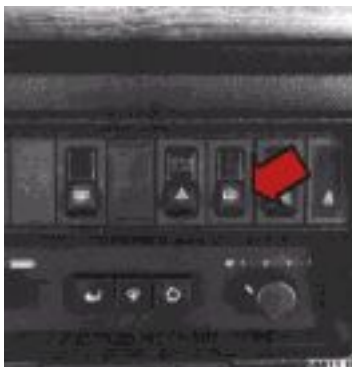

Heated door mirrors

Press the heated door mirrors switch to demist the mirrors. The orange light will light up. The system will be switched off automatically after 10-15 minutes or when the starting (ignition) key is switched off.



Parking brake (hand brake)

The lever is situated between the front seats. The brake is applied to the rear wheels. The PARKING BRAKE reminder light on the instrument panel comes on whenever the parking brake lever is not fully released and the ignition is on.

Always use the parking brake (hand brake) when parked.

In order to obtain the best possible performance of the parking brake, the brake lining should be broken in. (See section titled "Breaking in period".)

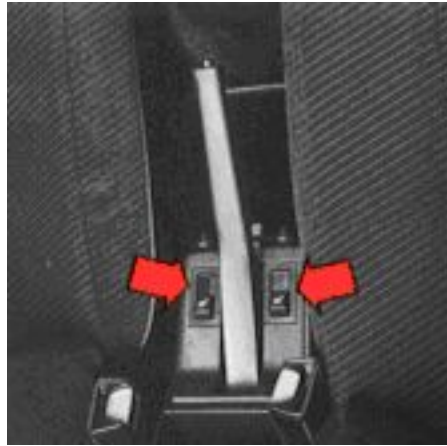

Seat heaters

Heated front seats are equipped with electrically-heated backrests and seat cushions which operate only when the seat is occupied. The switches engage the heating which then is thermostatically controlled. It switches on automatically when the temperature drops below 60°F (15°C) and switches off at approx. 96°F (35°C).



[Contents](#) | [Top of Page](#)

pg. 20 Cigarette lighter, Ash trays

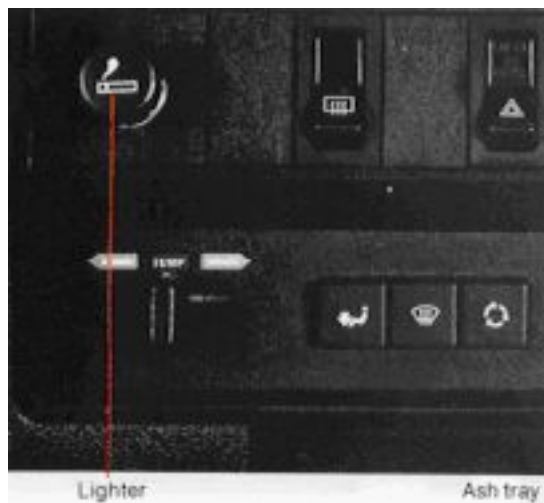

Cigarette lighter

To operate, depress the knob fully. When the knob automatically releases, the cigarette lighter is ready for use.

The starting (ignition) switch must be ON for the cigarette lighter to function.

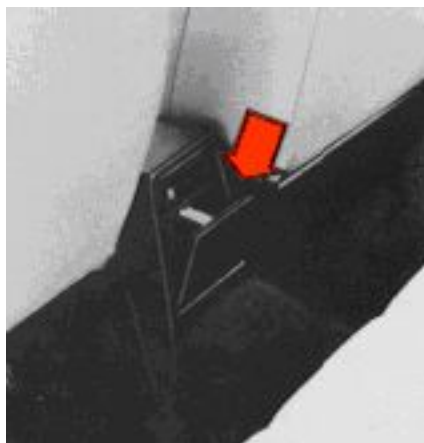

Ash trays

To remove the ash trays depress the center spring and remove.

pg. 21 Electrically-operated windows

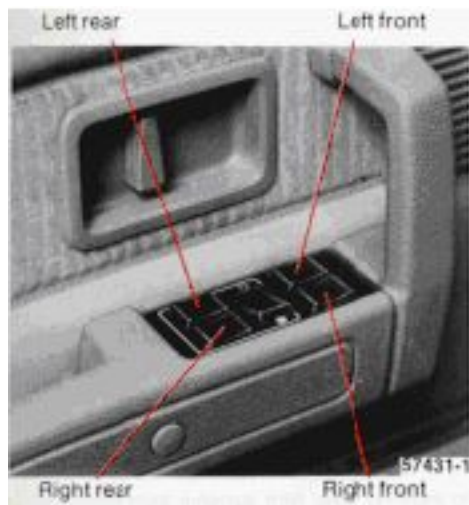

Electrically-operated windows
(standard on certain models)

The electrically-operated windows are controlled by switches set in the door arm rests. All the windows can be controlled from the driver's arm rest as shown in the above illustration.

The starting (ignition) switch must be ON for the electrically-operated windows to function. The window is lowered if the rear part of the switch is pressed and raised if the front part of the switch is pressed.

Warning: Remove the starting (ignition) key from the car when children are left alone in the car. Make sure that children's hands are clear before raising the windows.

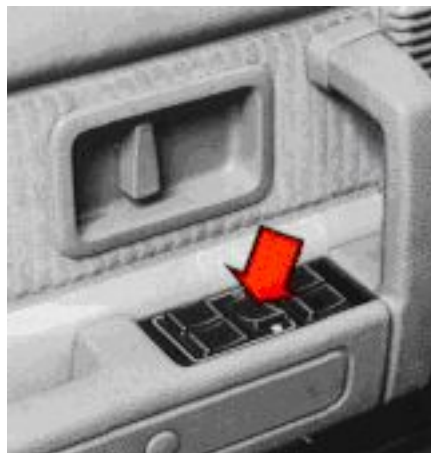

Cut-out switch for rear-door electrically-operated windows

If the car is equipped with rear-door power windows, this function can be disabled by a switch located on the driver's door armrest. This switch is position 90° in relation to the other switches.

The rear door windows can be raised or lowered with the respective door switch as well as the switch on

the driver's door.

The rear-door windows cannot be raised or lowered with the respective door switch but instead only with the corresponding switch on the driver's door.

pg. 22 Heating and ventilation

Heating system

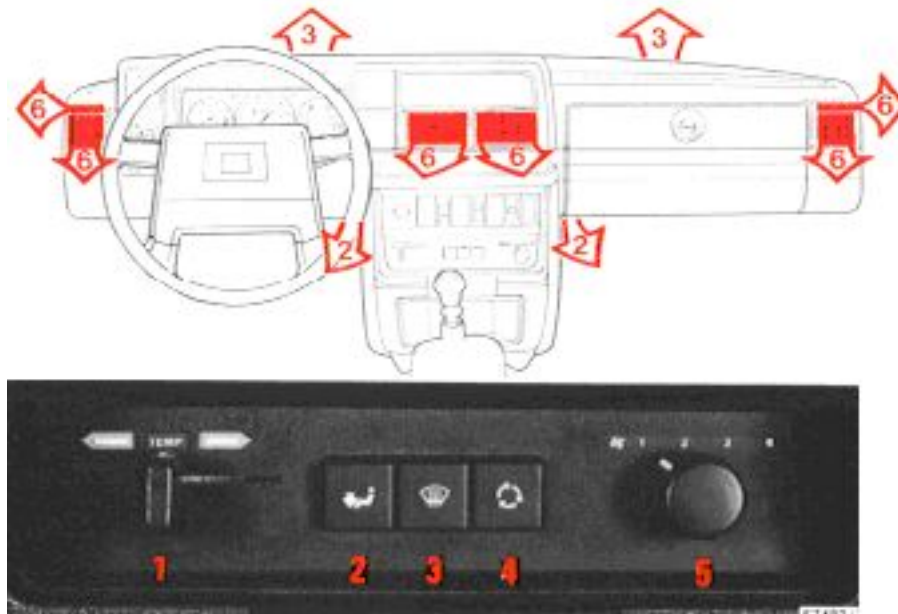

1 TEMP

Left = cool

Right = warm

2 FLOOR

Out = no air to floor

In = full flow of air to front and rear floor

3 Defrost

Out = low volume air flow to defroster

In = full flow

4 REC (recirculation)

To be used only on cars equipped with air conditioning.

Do not use for heating.



Out = full flow of outside air

In = air is recirculated for faster cooling

5  Blower motor

Has 4 speeds and is shut completely off when the knob is turned to the left.

6 Air louvers-dash

The air flow through the louvers is decreased when the  (2) and/or  (3) controls are depressed.

pg. 23 Heating and ventilation (cont.)

How to ...

... obtain max. heat

1 TEMP WARM

2  depressed

5 FAN  3 (or 4)

6 All dash louvers halfway open.

...remove condensation

1 TEMP WARM

3 DEF  depressed

5 FAN  3 (or 4)

6 All louvers closed.

Always keep front external inlet grille (in front of the windshield) clear of obstructions (snow, ice, etc.).

Maximum defroster action

For maximum defroster capacity at very low ambient temperatures, use the recirculation control (button depressed).

If not using air conditioning, the recirculation feature should not be used for more than 10 - 15 minutes since the air inside the car will become stale.

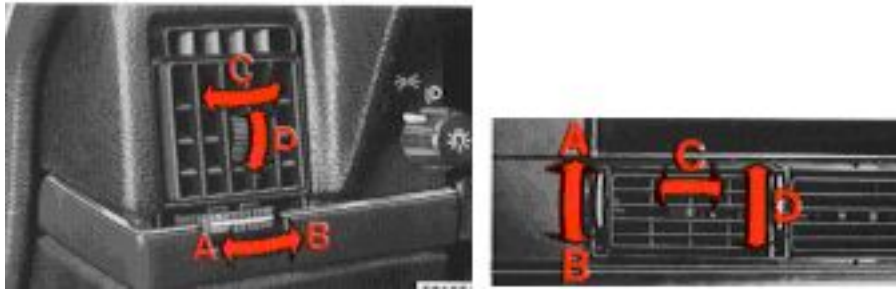

Air louvers - dash



- A Closed
- B Open
- C Directing air flow horizontally
- D Directing air flow vertically

pg. 24 Air conditioning



Air conditioning

How to use the air conditioner:



- 1  Blower switch
Position 4 for rapid cooling.
- 2 Air conditioning (compressor) switch
Start the air conditioning by pressing the panel switch. The system activates after a slight delay.
- 3  Recirculation
Push in for rapid cooling and during high humidity conditions.
- 4 TEMPERATURE
The selector should be in the leftmost position when the system is started. The TEMP selector can then

be used to adjust the temperature.

Left = cool

Right = warm

The air conditioning system in your car contains a CFC-free refrigerant - R134a. This is an environmentally friendly substance having minimal effect on the earth's ozone layer. The system contains 1.5 lbs (0.7 kg) R134a.

To obtain rapid cooling, all windows must be closed and buttons  and  out. Cool air will then be discharged through the four dash outlets which should be fully open.

Note: For rapid removal of condensation from inside glass surfaces, the air conditioner can be switched on even when not required for interior cooling. The air conditioner will dehumidify the air inside the vehicle.

Water under the vehicle in hot weather can be the result of condensation from the air conditioning system.

Have your Volvo dealer check the system for correct operation yearly. The air conditioning system should be operated periodically to ensure troublefree performance year round.



[Contents](#) | [Top of Page](#)

pg. 25 Audio System

The following pages describes the use of your TD-613 tuner deck.

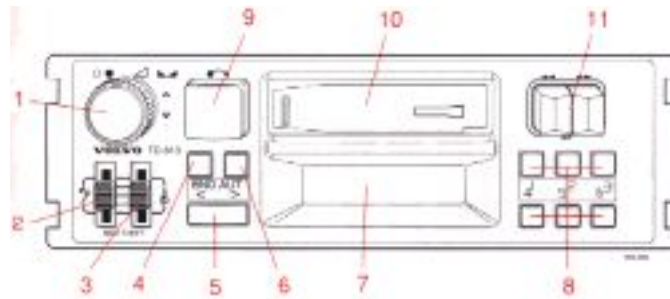

1.

- On/off (turn)
 - Volume (turn)
 - Balance left/right (push-turn)
 - Fader front/rear (pull-turn)
2. Bass control
3. Treble control
4. Waveband selector
5. Frequency tuning
6. Autostore
7. Display
8. Preset buttons
9. Cassette eject
10. Cassette slot
- 11.
- Lockable fast winding (left/right)
 - Tape direction selector (press both buttons)

pg. 26 Anti-theft code

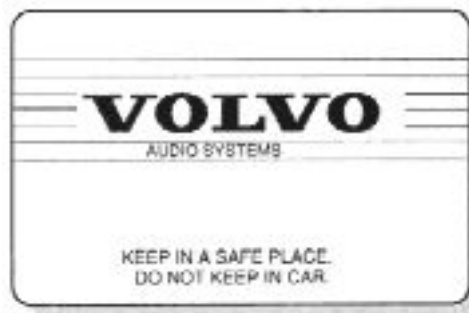

Anti-theft code

The radio features anti-theft circuitry. If the set is removed from the vehicle or if the batter power is disconnected, a special code must be entered to enable operation of the set.

Refer to the radio code card supplied with your vehicle or ask your dealer for the correct code.

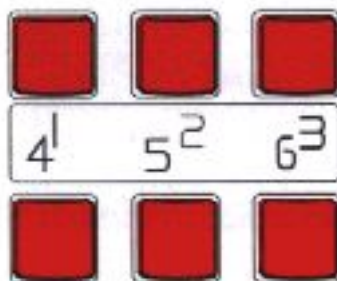
Using the code

After installation or when the set has been disconnected from power, the set displays "codE" when it is switched on.

Enter the 4-digit code using the preset buttons. If the correct code is entered, "codE" is no longer displayed and the set is ready to use.

Incorrect code

If an incorrect code has been entered "EEE" is displayed for 1 second and the "codE". Enter the correct code.

After three unsuccessful coding attempts the set will lock and remain locked for 2 hours. After two hours have elapsed, re-enter the correct code.

NOTE: During the two hour waiting period, the set must be connected and turned on.

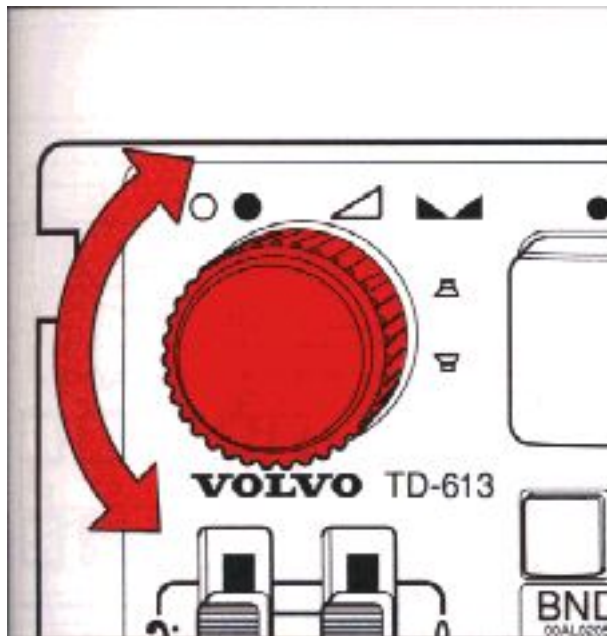

On/off switch and volume control

Turn the button clockwise to switch on and to increase volume.

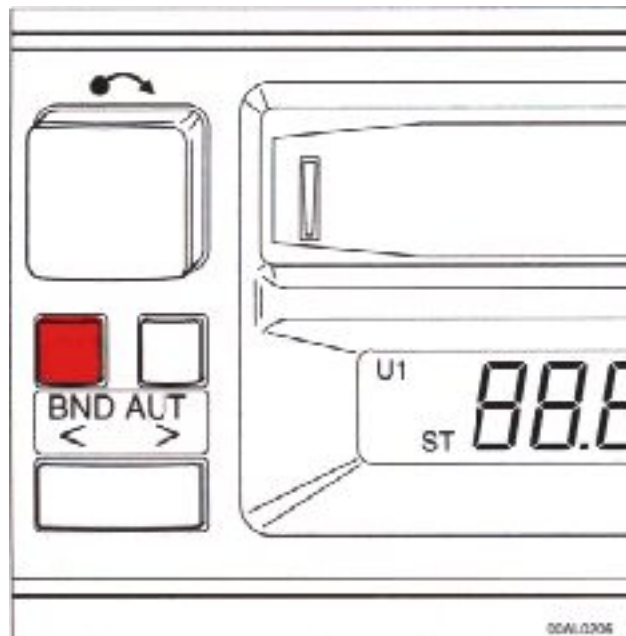

Waveband selector

The desired waveband is set by pressing the button. The frequency and waveband is shown on the display.

NOTE! There are two FM wavebands and one AM waveband.
This makes it possible to store more FM stations in the memory.

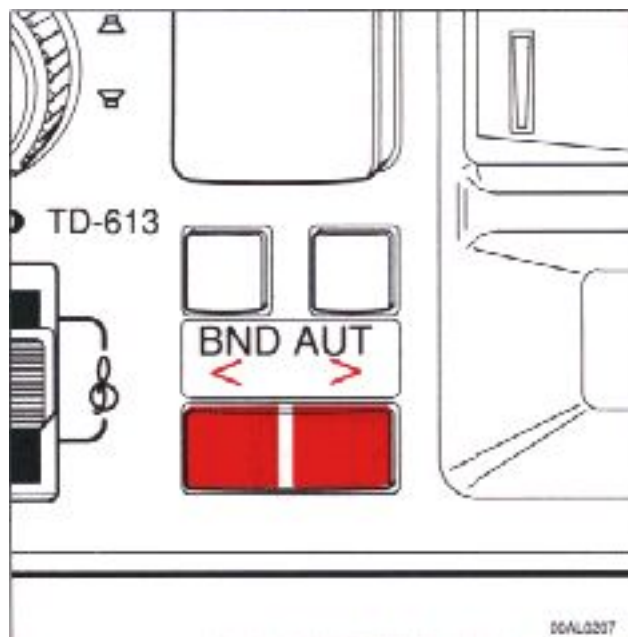

Manual tuning

Press the left side of the button to tune down and the right side to tune up. Release the button when the desired frequency is displayed.

pg. 28 Radio (cont.)

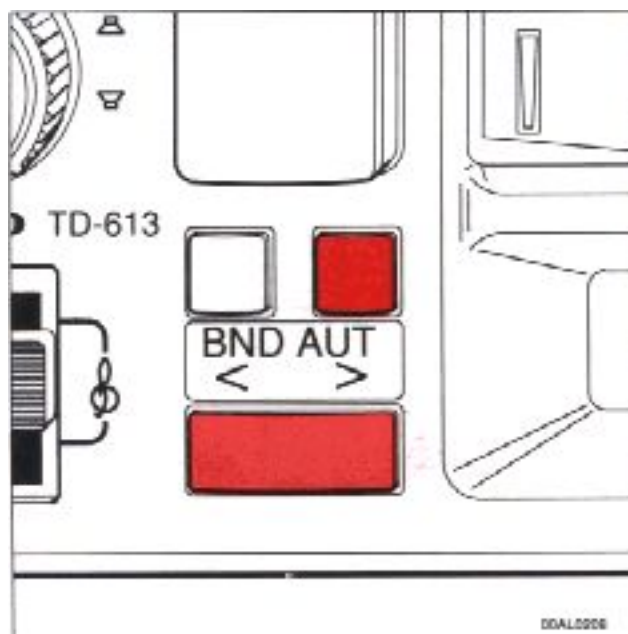

Automatic programming (autostore)

This function works on the FM and AM wavebands and has 8 memories in autostore mode on each waveband. The antenna must be fully extended when this function is used.

1 Press and hold the "AUT" button until "a" is displayed. A maximum of 8 strong stations on the

selected waveband is automatically stored in the autostore memory.

The lowest frequency station will now be heard. If there are no audible stations "---" will be displayed.

2 Press the "AUT" button once again if you wish to listen to another memorized autostored station. For each press a new station is set. Change between stations in the autostore memory by pressing the tuning button to the left or right.

3 Press one of the preset buttons to leave the autostore mode.

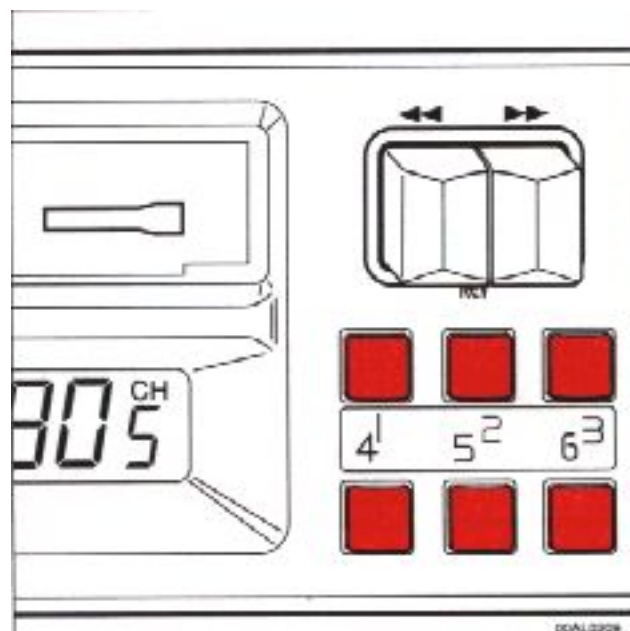

Preset buttons

To select a pre-programmed radio frequency, depress the preset button. The preset button number and frequency will be displayed.

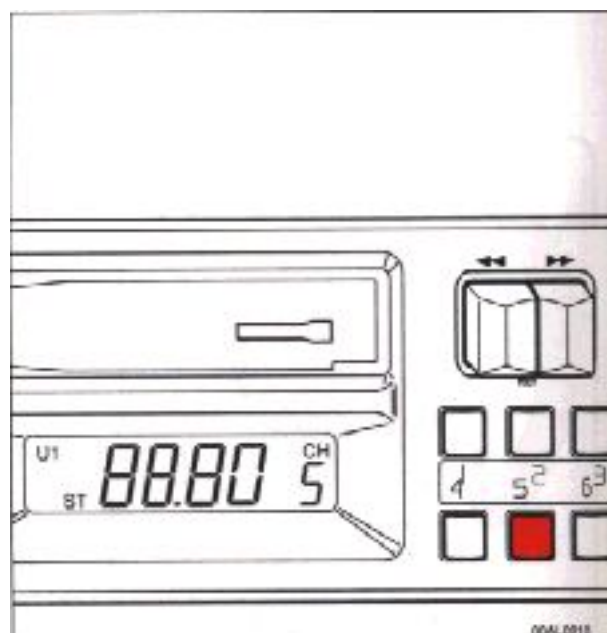

Preset programming

- 1 Tune in to desired frequency.
- 2 Depress a preset button. The audio cuts out. Keep the button depressed until the audio comes on (approx. 2 sec.)
- 3 The frequency is now stored on this preset button.

pg. 29 Radio (cont.)

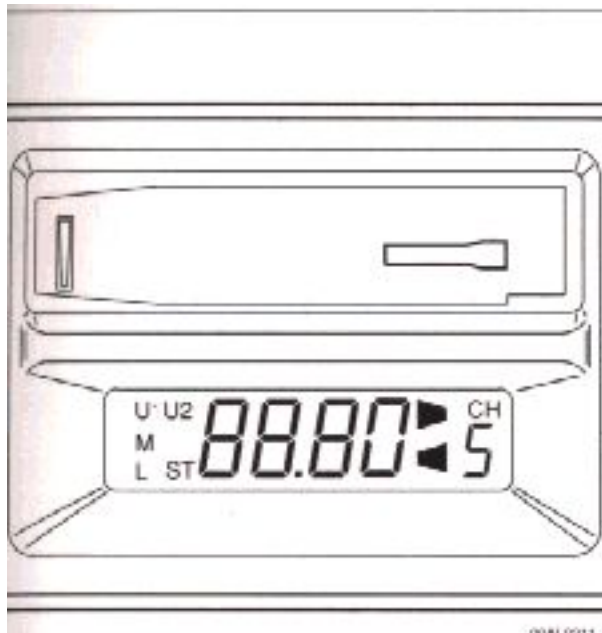

Display

The display shows the selected waveband, preset number, frequency and ST (stereo).

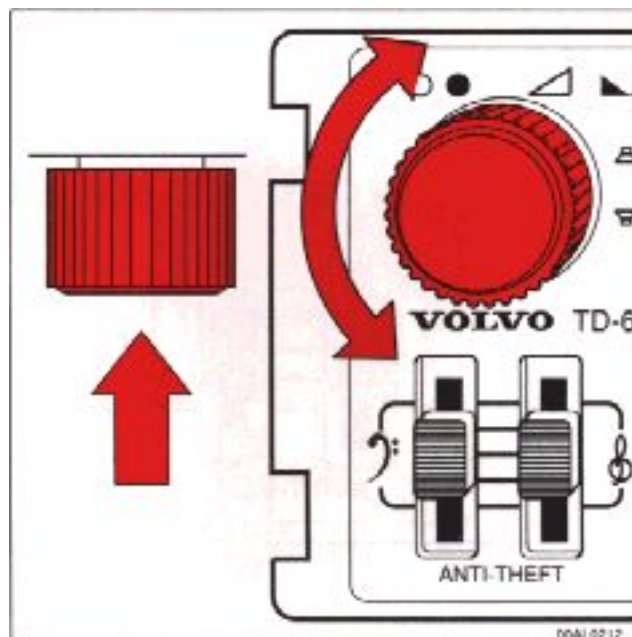

Balance control

Push in the knob and turn to the left or right to adjust left/right speaker balance. The "detent" indicates the "equalized" left/right balance position.

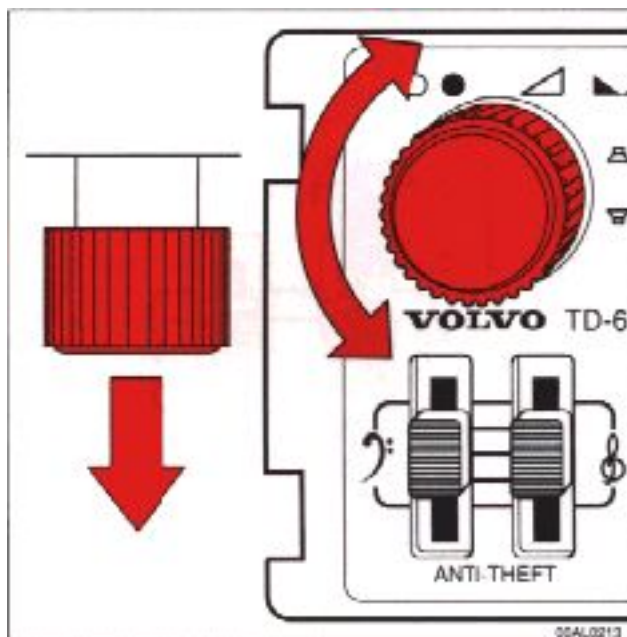

Fader control

Pull out the knob and turn it to the left or right to adjust front/rear speaker balance. The "detent" indicates "equalized" front/rear balance position.

pg. 30 Radio (cont.)

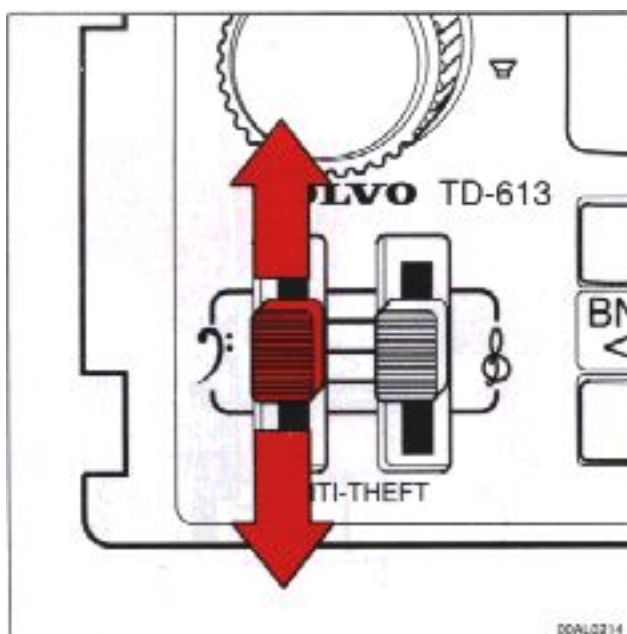

Bass control

Adjust the bass by moving the control up or down.
The "detent" indicates "equalized" bass.

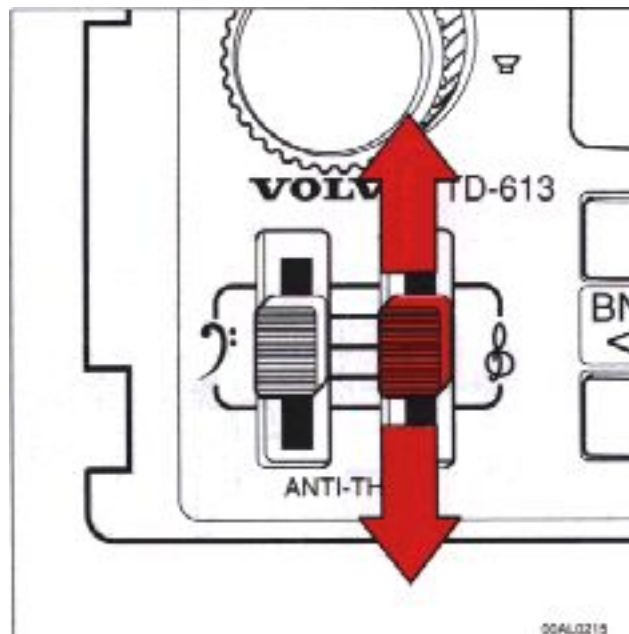

Treble control

Adjust the treble by moving the control up or down.
The "detent" indicates "equalized" treble.



[Contents](#) | [Top of Page](#)

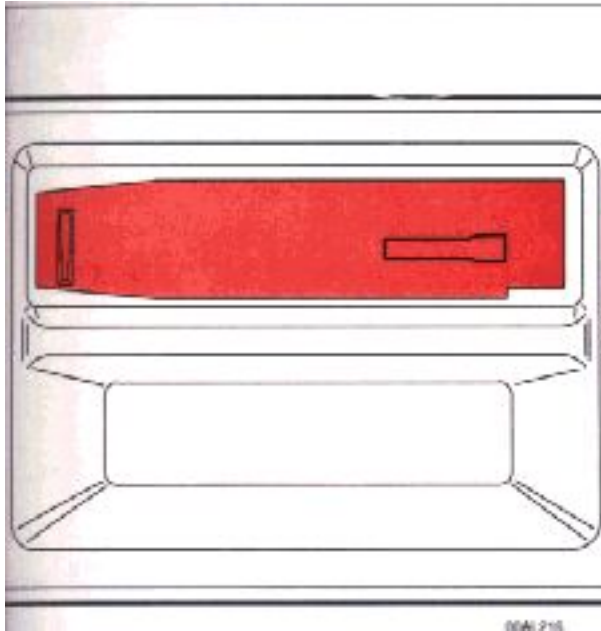

Cassette slot

The cassette is inserted with the roll of tape to the right-hand side. When the cassette is inserted, the radio is automatically disengaged. Push the cassette gently into place. The cassette will start to play automatically. The arrows show the tape direction (see illustration, column 2). When one side of the tape has been played the unit will automatically play the other side (auto-reverse). If the unit is switched off while playing a cassette, the cassette will remain in position. The drive rolls will be disconnected in order to avoid tape tangle (pinch-off).

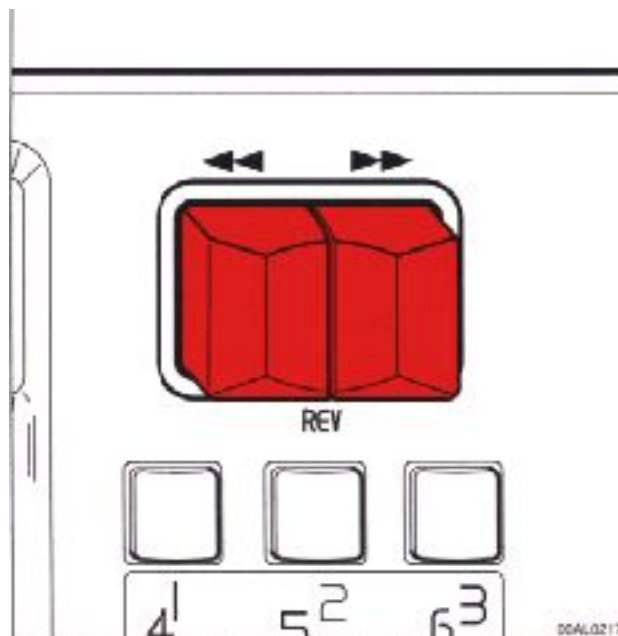

Reversing the tape

Depress both buttons to play the other side for the tape. The arrows in the display indicate the direction

of the tape.

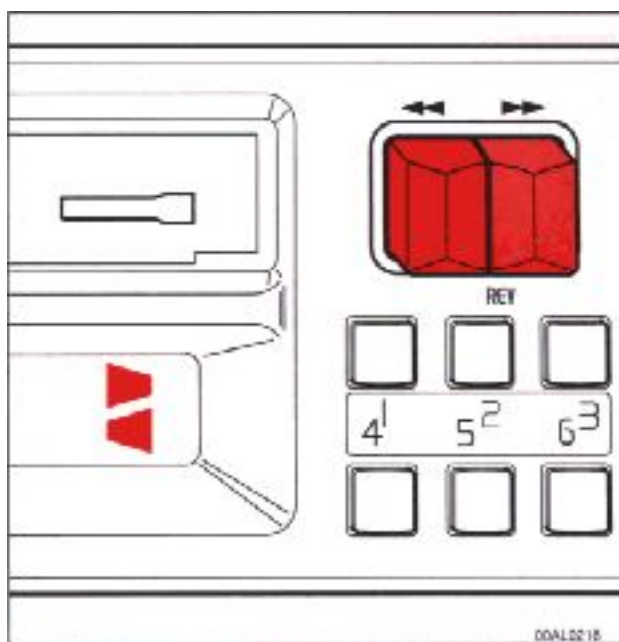

Fast winding

Press either of these buttons (see arrows for direction) for fast winding. Depress fully to lock the button. Press the opposite button to stop fast winding.

pg. 32 Cassette deck (cont.)

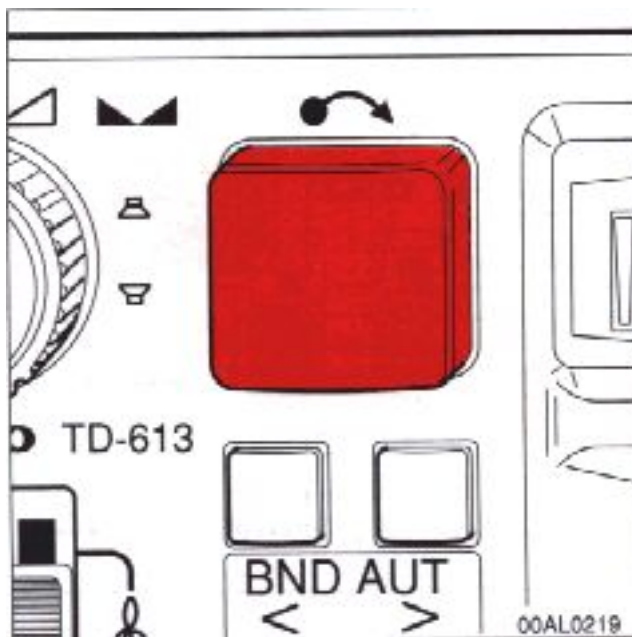

Cassette eject

If the button is pressed the tape will stop and the cassette will be ejected. The radio will be automatically engaged.

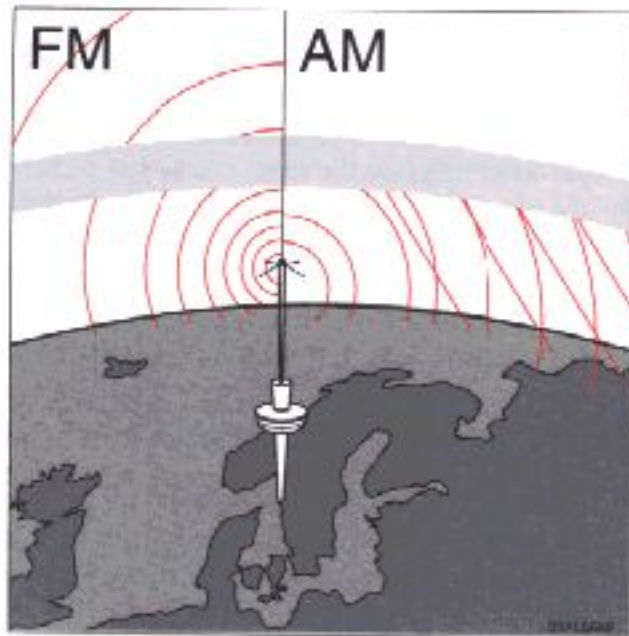

Sending signals

The FM waves do not follow the earth's surface, nor do they bounce off the atmosphere. For this reason their range is limited.

The AM waves follow the earth's surface and reflect against the atmosphere. This gives them a wide range.

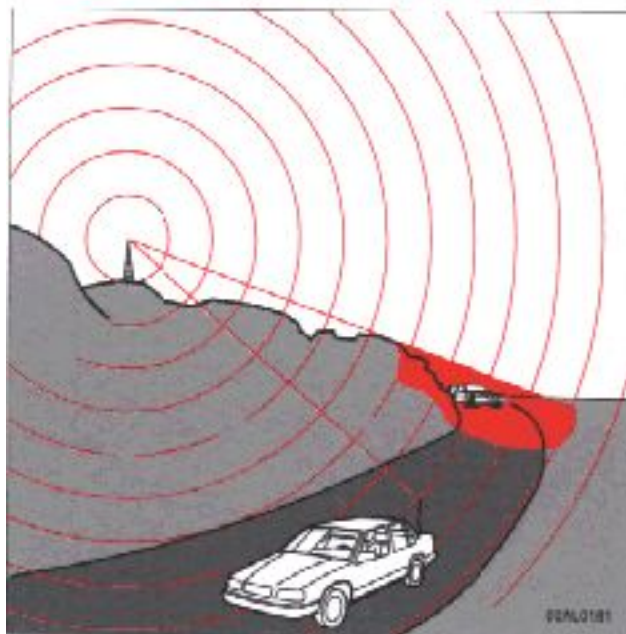

Weak reception (fading)

Because of the limited range of the FM senders and the fact that these waves are very reflective this problem usually occurs with FM reception. If the sender is blocked by buildings or mountains distortion can result.

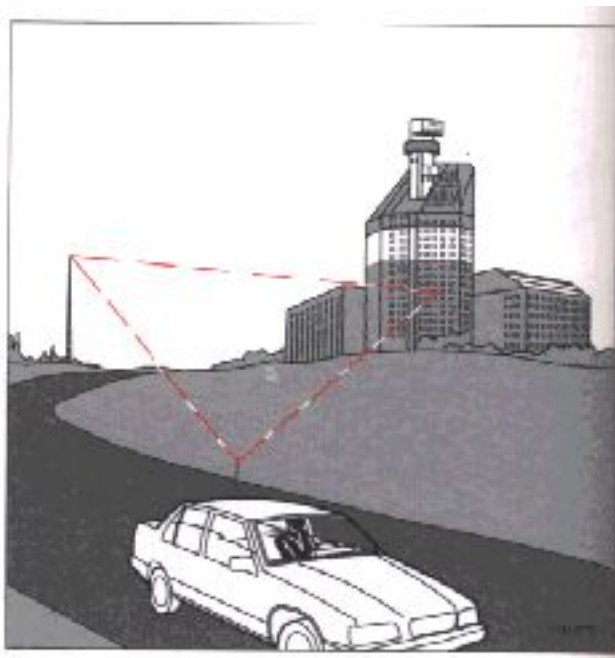

Distortion

The reason why FM but not AM is audible in covered parking areas, under bridges etc. is that FM signals reflect against solid objects such as buildings.

Because these waves are very reflective multipath distortion can result. This distortion is the result of the reflected signal and the direct signal reaching your antenna at slightly different time causing a cancellation of all signals. This problem occurs largely in built-up areas.

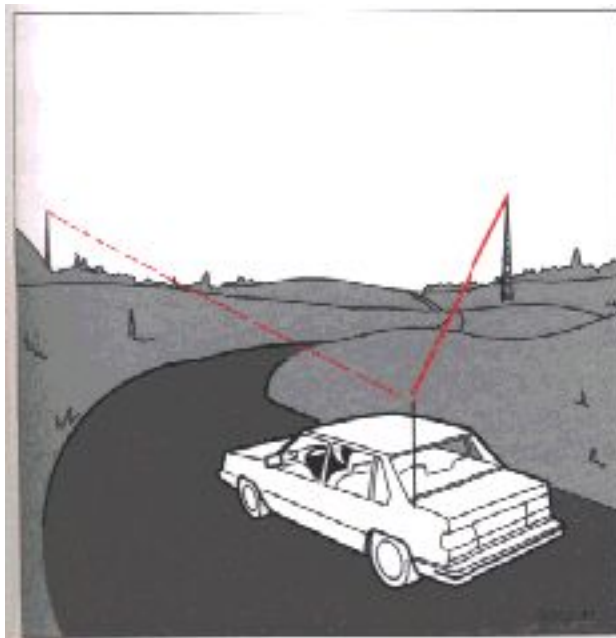

Cross modulation

If you listen to a weak station in the vicinity of a stronger one, both stations may be received simultaneously.

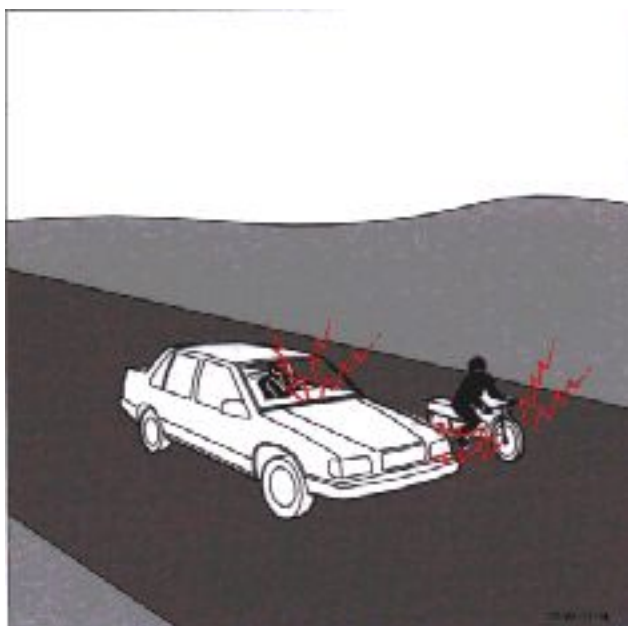

FM - reasons for distortion

FM is affected by the electrical systems of nearby vehicles, especially those without suppression. The distortion increases if the station is weak or poorly set. The FM reception is not as sensitive to electrical disturbances as AM.



AM - reasons for distortion

AM reception is sensitive to electrical disturbances such as power lines, lightning etc.

pg. 35 Radio

FM stereo reception

Stereo reception places very high demands on the signal quality which means the types of distortions previously mentioned become even more obvious. The signal strength needs to be stronger for good stereo reception and this limits the effective range of the sender.

We hope that this information proves to be useful and provides you with a better understanding of the problems related to car radio reception.

Reception conditions are not always optimum and this is, of course, beyond our control.

However, we have endeavored to make the Volvo Audio System of a quality so that you can enjoy the best possible reception no matter what the reception conditions may be.

Radio antenna mast

NOTE: Always lower the antenna when using an automatic car wash or entering a garage. The antenna should be cleaned every 10,000 miles (16,000 km) or more frequently if needed. Use WD40 for cleaning.

- Spray the antenna with WD40 and wipe it clean and dry with a rag.

Spray it again.

- Lower and raise the antenna. Wipe it clean and dry again.
- Lower and raise the antenna 4-6 times. Make sure it's dry and free from dirt/lubricating oil.

pg. 36 Technical specifications

Cassettes

- Store cassettes in their cases.
- Do not touch the tape surface with your fingers.
- Tapes should not be exposed to direct sunlight or extreme temperatures.
- Keep tapes away from oil, grease and other contaminants.
- Take up slack using a pen or a pencil before inserting cassette in cassette slot.

Cleaning cassette

We recommend the use of Volvo Cleaning Cassette available as a genuine Volvo accessory. Regular use helps maintain sound quality, cleans vital parts and helps prevent tape tangle.

Technical Specifications

System voltage: 12 Volts, negative ground

Fuse: 5 A

Radio

System: Superheterodyne system with HF-step.

Electronic suppression device

Frequency range:

TD-613 FM 87.9 - 107.9 MHz

AM 530 - 1700 kHz

Sensitivity: U(FM) 1.5 V

M(AM) 6.5 V

L 30 V

Cassette deck 4-track, 2-channel stereo

Tape speed: 4.76 cm/sec.

Pinch-off



[Contents](#) | [Top of Page](#)

VOLVO CONCERN FOR SAFETY

Safety is the cornerstone of Volvo. Our concern dates back to 1927 when the first Volvos rolled off the production line. Three-point seatbelts, safety cages, and crumple zones were designed into Volvo cars long before it was fashionable or required by government regulations.

We will not compromise our commitment to safety. We will continue to seek out new safety features and to refine those already in our cars. You can help. We would appreciate hearing your suggestions about improving automobile safety. We also want to know if you ever have a safety concern with your car. Call us in the U.S. at: 800-458-1552, or in Canada at: 800-663-8255. Thank you.

Occupant safety

How safely you drive doesn't depend on how old you are but rather on

- how well you see
- your ability to concentrate
- how quickly you make decisions under stress to avoid an accident.

These tips listed below are suggestions to help you cope with the ever changing traffic environment.

- Never drink and drive.
- If you are taking any medication, consult your physician about its potential effects on your driving abilities.
- Take a driver-retraining course.
- Have your eyes check regularly.
- Keep your windshield and headlamps clean.
- Replace wiper blades when they start to leave streaks.
- Take into account the traffic, road and weather conditions, particularly with regard to stopping distance.

Reporting Safety Defects In the U.S.

If you believe that your vehicle has a defect which could cause a crash or could cause injury or death, you should immediately inform the National Highway Traffic Safety Administration (NHTSA) in addition to notifying Volvo Cars of North America.

If NHTSA receives similar complaints, it may open an investigation, and if it finds that a safety defect exists in a group of vehicles, it may order a recall and remedy campaign.

However, NHTSA cannot become involved in individual problems between you, your dealer, or Volvo Cars of North America.

To contact NHTSA, you may either call the Auto Safety Hotline toll-free at 1-800-424-9393 (or 366-

0123 in Washington, D.C. area) or write to: NHTSA, U.S. Department of Transportation, Washington, D.C. 20590.

You can also obtain other information about motor vehicle safety from the Hotline.

pg. 38 Child safety

Volvo recommends the proper use of restraint systems for all occupants, including children. Remember that regardless of age and size, a child should always be properly restrained in a car. Restraint systems for children are designed to be secured in the vehicle by lap belts or the lap portion of a lap-shoulder belt. Such child restraint systems can help protect children in cars in the event of an accident only if they are used properly. However, children could be endangered in a crash if the child restraints are not properly secured in the vehicle. Failure to follow the installation instructions for your child restraint can result in your child striking the vehicle's interior in a sudden stop.

Holding a child in your arms is NOT a suitable substitute for a child restraint system. In an accident, a child held in a person's arms can be crushed between the vehicle's interior and an unrestrained person. The child could also be injured by striking the interior, or by being ejected from the vehicle during a sudden maneuver or impact. The same can also happen if the infant or child rides unrestrained on the seat or in the cargo section of a station wagon. Other occupants should also be properly restrained to help reduce the chance of injuring or increasing the injury of a child.

All states and provinces have legislation governing how and where children should be carried in a car. Recent accident statistics have shown that children are safer in rear seating positions than front seating positions when properly restrained.

A child restraint systems can help protect a child in a vehicle. Here's what to look for when selecting a child restraint system:

- It should have a label certifying that it meets applicable Federal Motor Vehicle Safety Standards (FMVSS 213-80) - or in Canada, CMVSS 213.
- Make sure the child restraint system is appropriate for the child's height, weight and development - the label required by the standard or regulation, or instructions for infant restraints, typically provide this information.
- In using any child restraint system, we urge you to carefully look over the instructions that are provided with the restraint. Be sure you understand them and can use the device properly and safely in this vehicle.
- A misused child restraint can result in increased injuries for both the infant or child and other occupants in the vehicle.

When a child has outgrown the child safety seat, you should use the rear seat with the standard seat belt fastened. The best way to help protect the child here is to place the child on a cushion so that the seat lap belt is as far down on the hips as possible.

A specially designed and tested safety cushion for this purpose can be obtained from you Volvo dealer.

If necessary, an optional auxiliary third seat is available for use in the luggage compartment of station wagon models. This seat is designed for two children, each up to 88 lbs. in weight and up to 59 inches in height.

pg. 39 Child restraint

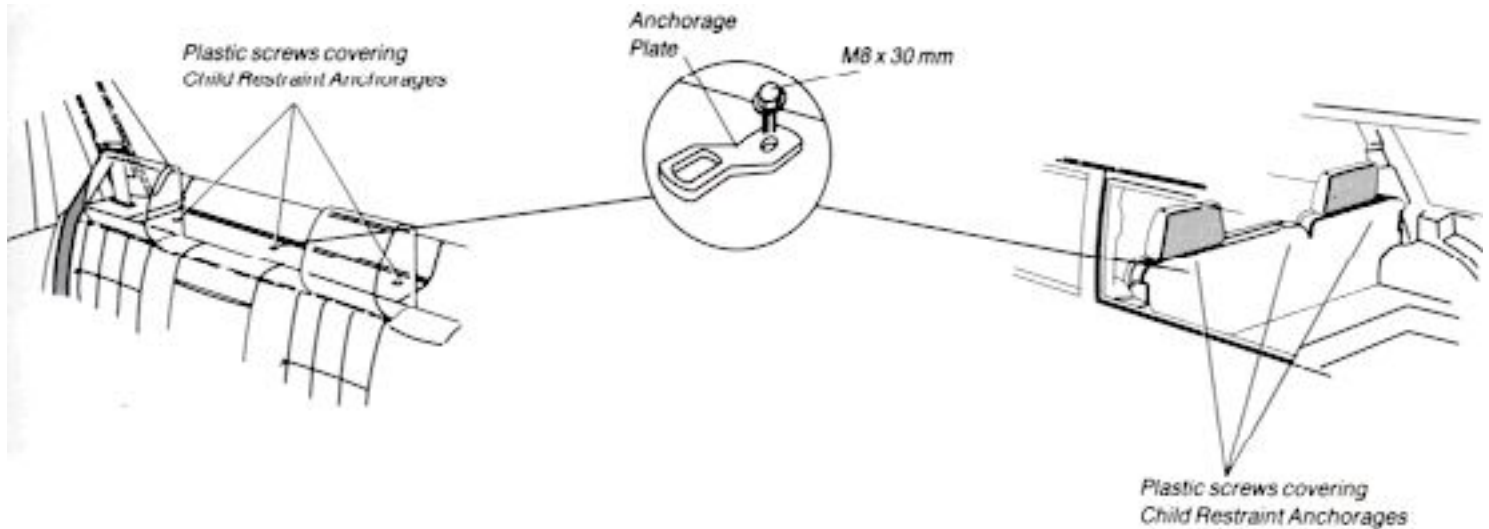

Child Restraint Anchorages

Volvo cars are fitted with child restraint top tether anchorages in the rear seat. There are three anchorages under the rear section of the car's rear window shelf on sedans in the back of the rear seat in wagons. When the car is delivered, the holes for these anchorages are covered by plastic covers. In cars designed for Canada, on top tether anchorage set will be in the glove box. The top there anchorage set includes the top tether anchorage plate, an 5/16 UNC bolt and a plastic trim cover. If another set is needed, consult your Volvo dealer.

Installing top tether

Remove the plastic cover covering the anchorage point you want to use. This can be done with a suitable coin. The cover is removed counterclockwise.

Refer to the child seat manufacturer's instructions for securing the seat.

An additional bolt may be required for sedans. This may be obtained from your authorized Volvo dealer.

WARNING!

Child Restraint Anchorages are designed to withstand only those loads imposed by correctly fitted Child Restraints. Under no circumstances are they to be used for adult seat belts or harnesses. The anchorages are not able to withstand excessive forces on them in the event of a collision in full harness seat belts or adult seat belts are installed to them.

An adult who uses a belt anchored in a Child Restraint Anchorage runs a great risk of suffering severe injuries should a collision occur.

pg. 40 Seat belts

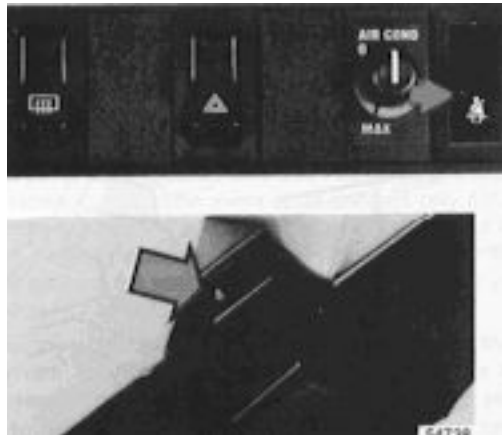

Seat belts, retractable

Always fasten the seat belts before you drive or ride.

Two lights will be illuminated for 4-8 seconds after the starting (ignition) key is turned to driving position. One light is located in the instrument cluster and one in the console between the front seats. A chime will sound at the same time if the driver has not fastened his seat belt. The front and rear outboard seats are provided with self-retracting inertia-reel belts.

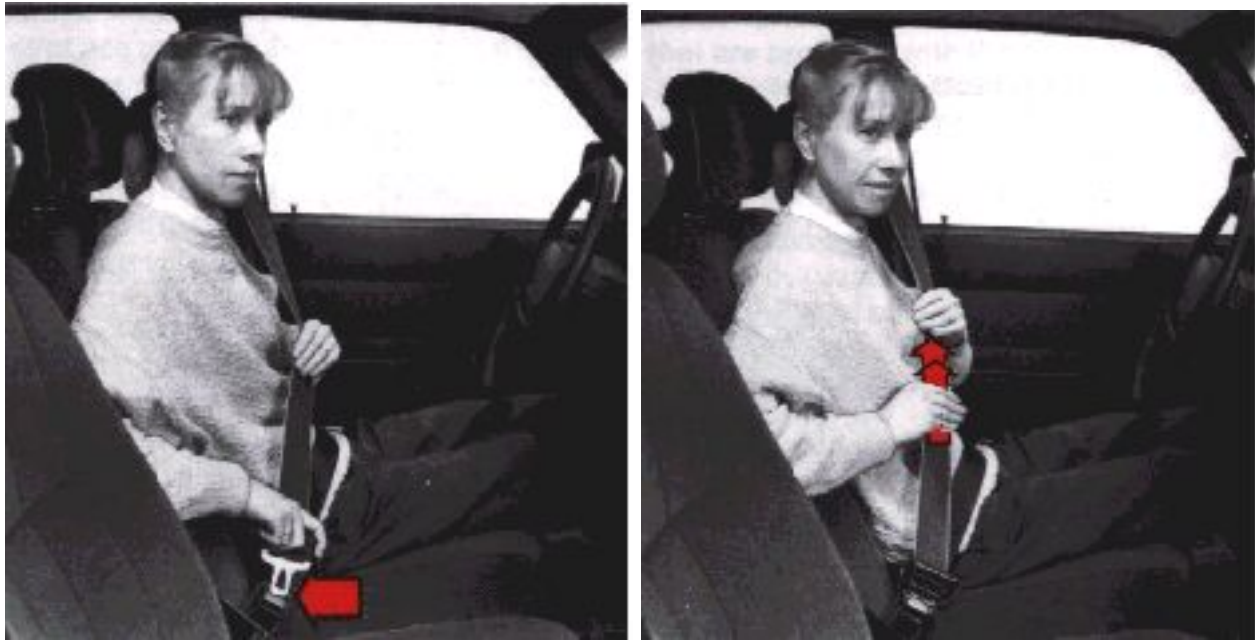

To buckle:

Pull the belt out from the retractor far enough to insert the latch into the buckle until a distinct snapping sound is heard. The belt should not be twisted or turned.

Note: The lap belt should sit low and tight under abdomen.

To unfasten, depress red pushbutton in buckle and let the belts rewind into their retractors. Before exiting the car, check that the seat belt retracts fully after being unbuckled. If necessary, guide the belt back into its retractor slot.

WARNING!

The seat back should not be tilted too far back. The shoulder belt must be taut in order to function properly.

The seat belt retractors are normally "unlocked".

The retractors will lock up as follows:

- if belt is pulled out rapidly
- during braking and acceleration
- if the vehicle is leaning excessively
- when driving in turns

Check seat belt mechanism function as follows:

1. Attach the seat belt. Pull rapidly on the strap.

2.

WARNING! Check other traffic before performing this check.

Brake firmly from approximately 30 mph (50km/h) or turn in a tight circle while pulling on the belt.

In all the above checks you should not be able to pull the belt out.

pg. 41 Seat belts (cont.)

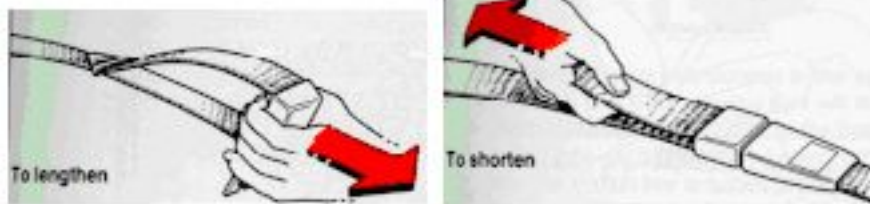

Seat belts, manually adjustable

The center-rear seat belt is manually adjustable. It should always be adjusted to fit snugly across the lap.

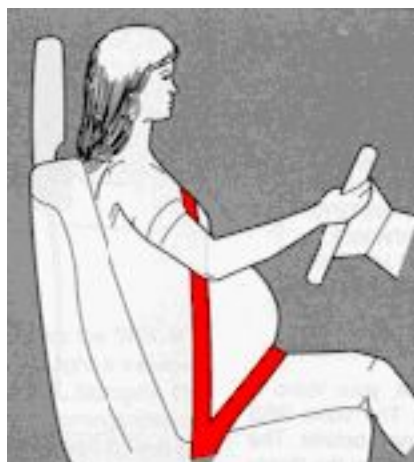

The lap belt should sit low under abdomen

During pregnancy

Pregnant women should always wear seat belts. Remember that the belt should always be positioned in such a way as to avoid any possible pressure on the abdomen. The lap portion of the belt should be located low, as shown in the above illustration.

WARNING: Never use any single seat belt for more than one occupant. Never wear the shoulder portion for the belt under the arm or otherwise out of position. Such use could, in event of accident, cause injury.

Volvo recommends that all occupants fasten their seat belts. Aftermarket devices used to induce slack into the shoulder belt portion of Volvo's three-point belt system will have detrimental effect on the amount of protection available to you in the event of a collision.

As the seat belts lose much of their strength when stretched, any occupied belt should be replaced after a collision, even though they may appear to be undamaged.

Never repair the belt on you own; have this done by an authorized Volvo dealer only.

Note: Legislation in you state or province may mandate seat belt usage.

Seat belt maintenance

Check periodically that the anchor bolts are secure and that the belts are in good condition. Use water and mild detergent for cleaning.

pg. 42 Supplemental Restraint System



As an enhancement to the three-point seat belt system, your Volvo is equipped with a Supplemental Restraint System (SRS). The Volvo SRS consists of a driver's side airbag with a driver's side knee bolster. The systems is designed to supplement the protection provided by the three-point seat belt system.

The interior of an SRS-equipped Volvo loos very much the same as any other. The only indications of the system's presence are the "SRS" embossed on the steering wheel pad, and the knee bolster beneath the steering column. Also, the SRS diagnostic receptacle is indicated on the center dash panel.

The airbag is folded and located in the center of the steering wheel. It is released only during certain frontal or front-angular collisions, depending upon the crash severity, angle, speed, and object impacted.

WARNING! As its name implies, SRS is designed to be a SUPPLEMENT to - not a replacement for - the three-point belt system. The airbag is not designed to be released in the event of a side or rear-end collision, or during a rollover situation. For maximum protection, wear seat belts at all times. Be aware that no system can prevent all possible injuries that may occur in an accident.



The airbag system includes a gas generator (1), surrounded by the airbag itself (2). To deploy the system, the sensor (3) activates the gas generator causing the airbag to be inflated with nitrogen gas. As the movement of the driver compresses the airbag, some of the gas is expelled at a controlled rate to provide better cushioning. The entire process, including inflation and deflation of the airbag takes approximately two-tenths of a second.

WARNING:

When installing any optional equipment make sure that the SRS system is not damaged. Do not attempt to service any component of the SRS yourself. Attempting to do so may result in serious personal injury. If a problem arises, take your car to the nearest authorized Volvo Dealer for inspection as soon as possible.

pg. 43 Supplemental Restraint System (cont.)



A self-diagnostic system incorporated in the sensor monitors the SRS. If a fault is detected, the "SRS" warning light will illuminate. The light is included in the warning indicator light cluster in the instrument panel. Normally, the SRS warning lamp should light up when the ignition is switched on and should go out after 10 seconds or when the engine is started. Check that this light is functioning properly every time the car is started.

The following items are monitored by the diagnostic system:

- Sensor unit.
- Cable harness
- Gas generator ignitor.

General SRS information

If the air bag deploys, some noise occurs and a small amount of powder is released. This powder is not harmful and does not indicate fire.

NOTE: Deployment of SRS components occurs only one time during an accident.

WARNING! Never drive an SRS equipped car with your thumbs on the steering wheel/airbag housing. If the SRS warning light stays on after the engine has started or if it comes on while you are driving, drive the car to the nearest authorized Volvo Dealer for inspection as soon as possible.

ATTENTION! SRS VEHICLE!

THIS CAR IS EQUIPPED WITH A SUPPLEMENTAL RESTRAINT SYSTEM. TO PROVIDE CONTINUED RELIABILITY, CERTAIN ELEMENTS OF THE SUPPLEMENTAL RESTRAINT SYSTEM SHALL BE SERVICED OR REPLACED BY JAN. XXXX. SEE OWNERS MANUAL FOR FURTHER INFORMATION.

VOLVO

The above is a sample for the decal which can be found on the left-hand door pillar.

If you are involved in an accident which has resulted in airbag deployment, we recommend the following:

- Have the car towed to an authorized Volvo dealer or collision repair shop. Even if the car is driveable after an accident, we do NOT recommend driving the car with a deployed air bag.
- Have the SRS replacement performed by an authorized Volvo dealer OR ask the body shop performing the collision repairs to have the SRS replacement done at a Volvo dealer.
- Have all deployed/damaged SRS components (air bag) and front seat belt assemblies replaced with

new, genuine Volvo-brand components.

There is no maintenance to perform on the SRS yourself. The only periodic maintenance recommended on the SRS is that the air bag module should be replaced approximately every ten years and that the other components in the system (wiring, connector, etc.) should also be inspected at this time. The SRS decal on your car shows the month and year servicing is due. This service must be performed by an authorized Volvo dealer.



[Contents](#) | [Top of Page](#)

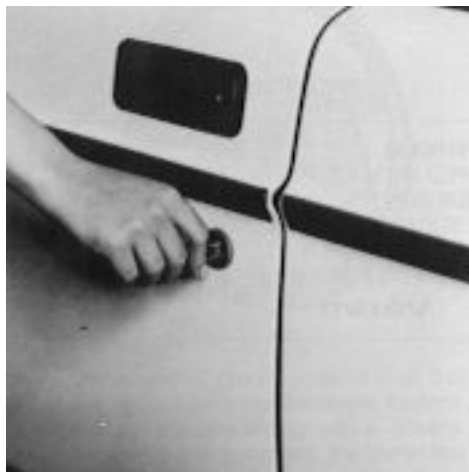

Unlocking front doors

Both front doors can be unlocked by using the starting (ignition) key. Turning the key 1/4 turn counter-clock wise (right door : clockwise) lifts the lock buttons on the window ledge and the door can be opened by pulling the handle. To open a door from inside, the lock button must first be pulled up.

Central lock

The vehicle is equipped with a central lock system. This means the lock on the driver's door automatically controls the locks on the other doors (including the trunk on Sedan models and the tailgate on the wagon model.)

Locking doors

Both front doors can be locked by using the key. Turning the key 1/4 turn clockwise (left door) clockwise (left door) or counter-clockwise (right door) locks the door.

NOTE: The driver's door can only be locked using the key.

The lock buttons should not be in the down (locked) position during driving. In case of an accident, this may hinder rapid access to the occupants of the vehicle.

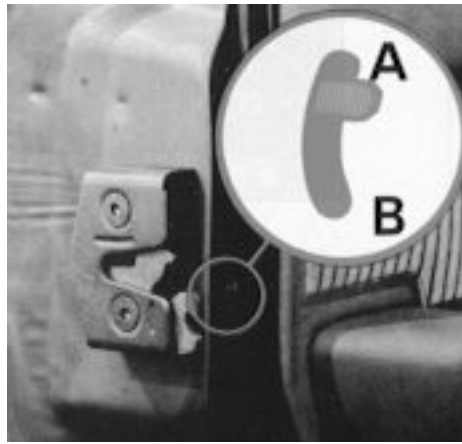

Child safety locks

The buttons are located on the rear door jambs.

A The lock functions normally

B The door cannot be opened from the inside

WARNING: In the event of an accident, the rear seat passengers cannot open the doors from the inside with the buttons in position B.

Wagon model contains child safety lock on tailgate. The lock differs from that shown above. See section titles "Wagon, tailgate".

pg. 45 Trunk lid, Trunk light



Trunk lid

The trunk lock is incorporated in the central locking system. This means that you can either lock or unlock the trunk by means of the driver's door lock.

You can also operate the trunk lock directly with the master key even if the vehicle is centrally locked.



Unlocking Locking
Withdraw key in vertical position

The trunk lock can also be disconnected from the central locking system by turning the key counterclockwise as shown below:



Withdraw key in horizontal position

The trunk is now always locked.

This option can be used if for example, you lend your car to somebody. If you give only the service key to the driver it will not be possible to open the trunk.

To reconnect the lock to the central locking system:



Withdraw key in vertical position

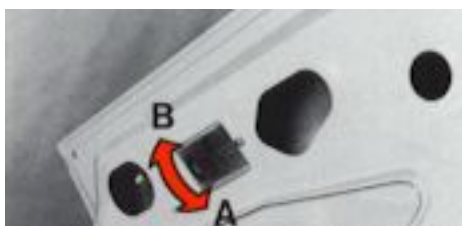

Trunk light

A Light always off.

B Light on when trunk lid is open.



To open the hood:

Pull the release handle (located under the left side of the dash).
Lift the hood slightly, insert a hand under the center line of the hood and depress the safety catch handle.
Open the hood.

WARNING!
Check that the hood locks properly when closing.



Long load storage (except wagon)

A flap in the rear seat makes it possible to carry "long loads" such as skis, etc.

WARNING!

When braking rapidly the load could be displaced and cause injury to occupants. Sharp edges on the load should be covered for protection. It is essential that the "load" be secured safely. Use belts locked around the folded down armrest (see illustration).

WARNING!

Do not place heavy objects on the window shelf. These objects can become dangerous projectile in the event of sudden braking. Always secure large or heavy objects with the seat belts.

Please note that the flap in the rear seat is intended only for light loads such as skis, wood, etc.

Max. length of load 6 1/2ft = 2m

Max. weight of load 33lbs = 15kg.

WARNING!

Take care when loading/unloading the vehicle. Always turn off the engine and apply the parking brake. Place automatic transmission gear shift selector in position P (Park). This will prevent accidental movement of the gear shift selector to position D (Drive).

pg. 47 Rear view mirror, Side-view mirrors, Power mirrors

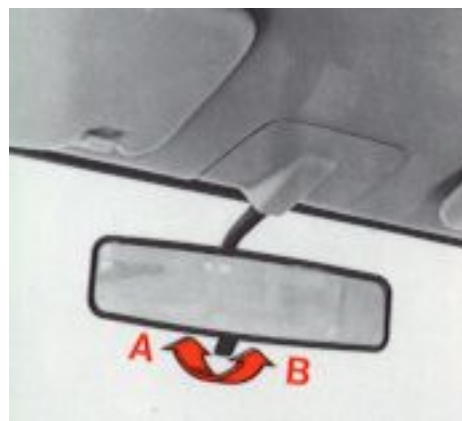

Rear view mirror

A Normal position

B Night position, reduces glare from following headlights



Side-view mirrors

A Adjustment up/down

B Adjustment sideways

Avoid using ice scrapers made of metal as they can easily scratch the mirror surface.

WARNING!

The mirrors should always be adjusted before driving. Objects seen in the wide angle right side mirror are closer than they appear to be.



Power mirrors (optional)

A Adjustment up/down

B Adjustment sideways

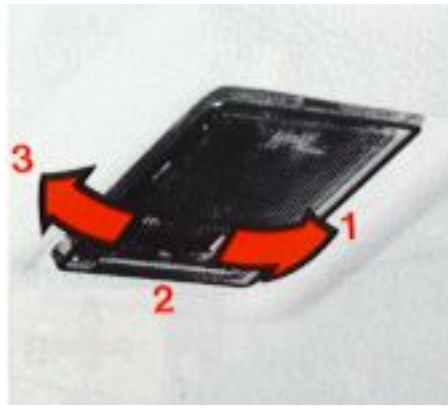

Interior light

1. Light always on.
2. Light always off.
3. Light is on when either of the front or rear doors are opened.

On certain models a time delay device illuminates the interior light for approx. 15 seconds after closing the driver's door. This facilitates finding starting (ignition) switch, etc., during darkness.



Refueling

The fuel tank cap is located behind the door on the right rear fender. Open cap slowly during hot weather.

When filling, position the cap in the special bracket on the door. After filling the tank, install the cap and turn until a "click" is heard.

The tank holds 15.8 gallons (60 liters).

An optional locking cap is also available. Refer to section titled "Fuel requirements" for additional information.



[Contents](#) | [Top of Page](#)

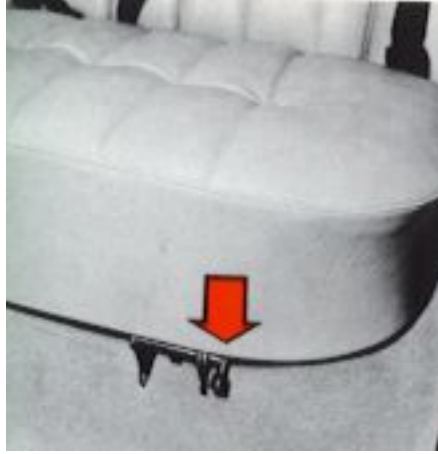

Folding rear seat

Depress either lever located at the front bottom edge of the rear seat cushion (right or left side). Tilt the seat towards the front seat.

Note: It may be necessary to move front seats forward or raise the seat backs slightly to allow rear seat to fold down.



Remove the head restraints from the rear seat by grasping the restraint and lifting straight up. Secure the head restraints. Pull the handle on the rear side of the seat back upwards, and fold the seat back forward and down so that it lies flat. The rear seat back and cushion are held automatically in their respective positions.

Warning: When returning the rear seat to its normal position, make sure the latches are securely locked and the seat belts are easily accessible for use.



Removing seat cushion

The seat cushion can be easily removed to provide a slightly larger cargo storage area. To remove, lift the seat cushion out of the hinges.

Warning: When the rear seat is folded down, do not place heavy objects against the backs of the front seats. This places a severe strain on the folded down backrest of the rear seat. Do not load luggage higher than the seat backs to avoid luggage being thrown forward in the event of sudden braking and causing injury to passengers.

pg. 50 Tailgate (wagon), Safety catch



To open from the outside:

Depress the release button located under the tailgate handle.

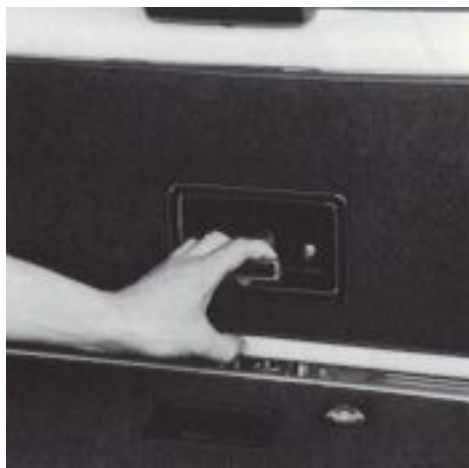

To open from the inside:

Pull out the T-handle located at the bottom of the tailgate.

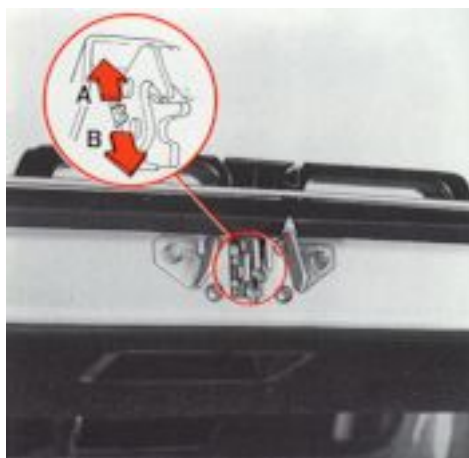

Safety catch

A The lid cannot be opened from the inside.

B The lock functions normally.



Spare wheel, jack

The spare wheel and jack are stored under the hatch to the left in the cargo compartment. Loosen the two clips 1/4 turn and lift off the hatch.

WARNING! Unless the station wagon is equipped with a cargo compartment seat (Volvo accessory), occupants should not ride in this section of the car.

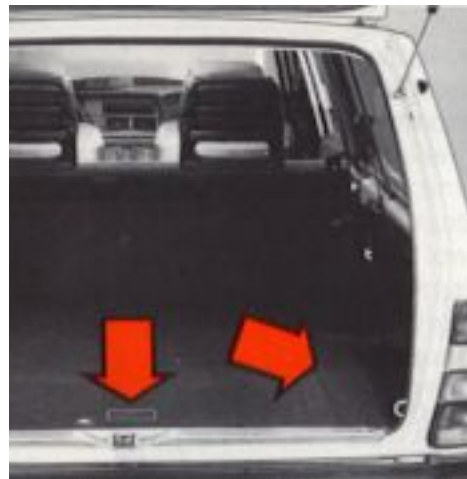

Concealed storage space

There are two concealed storage areas under the cargo compartment floor.

Locking floor lid

The larger lid is lockable and should be used when increased security for stored articles is desirable.



Eyelets

Six eyelets are provided in cargo compartment for anchoring cargo. Two eyelets are accessible when the seat back is folded forward.

WARNING! Luggage or other cargo should not be stowed higher than the seat backs. All items should be secure in place.
The eyelets are not to be used as occupant restraints or child seat restraints. See the section on Child Restraint Anchorages.

pg. 52 Front seats

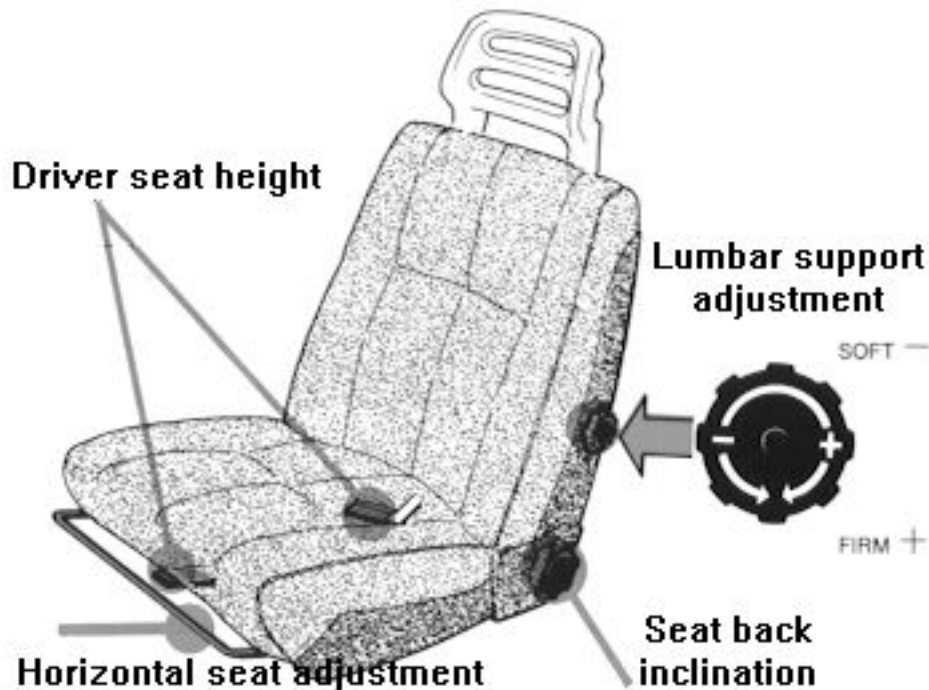

Driver seat height

There are two levers, each with three positions, for adjusting the height of the seat (front and/or back of cushion).

This allows adjustment of the seat cushion angle for added comfort.

After adjusting the seat check that it is securely latched.

Note: Do not attempt to raise seat height while seated.

Horizontal seat adjustment

Pull control upward, then slide seat forward or rearward to desired position.

Make sure that the seat is properly secured when you release the control.

Warning: For your safety, never adjust seat while driving. The seat should be adjusted so that the brake (and clutch) pedal can be depressed fully. In addition, position the seat as far rearwards as comfort and control allowed.

Passenger seat height

The front passenger seat is retained by four brackets. There are two height positions at the front and three at the rear. However, this adjustment must be accomplished manually, using appropriate hand tools.

Seat back inclination

Rotate control clockwise to tilt seat back rearward. Rotate counterclockwise to tilt seat back forward.

Note: Body weight must be shifted to allow seat back to move forward or rearward.



[Contents](#) | [Top of Page](#)

pg. 53 Operating the car

Subject	Page No.
Break-in period	54
Driving economy, shift indicator light	55
Starting the engine	56
Manual transmission	57
Automatic transmission	58
Emergency towing, towing information	61
Trailer hauling	62
Automatic transmission, brake system	63
Three way catalytic converter	64

pg. 54 Break-in period

A new car should be broken-in!

Manual transmission

During the break-in period do not exceed the following speeds*:

First 600 miles (1,000 km)

1st gear	20 mph	(30 km/h)
2nd gear	30 mph	(50 km/h)
3rd gear	50 mph	(80 km/h)
4th gear	70 mph	(110 km/h)
5th gear	80 mph	(130 km/h)

600 - 1,200 miles (1,000 - 2,000 km)

1st gear	25 mph	(40 km/h)
2nd gear	40 mph	(65 km/h)
3rd gear	60 mph	(100 km/h)

4th gear 80 mph (130 km/h)

5th gear 90 mph (150 km/h)

Avoid driving at low speed in high gear.

*These are the maximum speeds recommended by the factory. Note that legislation in different countries and states can stipulate other max. speeds than those given here.

Automatic transmission

Do not activate "kick-down" during the first 1,200 miles (2,000 km).

Breaking in parking brakes

To obtain best parking brake performance, the parking brake linings should be broken in. Stop 5-7 times from 30mph (50km/h), transmission in neutral, applying the parking brake with the release button pressed in during the stop. The force must not lock the rear wheels. If this happens, release the brake enough to let the wheels rotate. Drive a mile between each stop to cool the brakes. Check for proper parking brake operation.

WARNING!

The brake light are not illuminated when applying the parking brake. To warn traffic from behind it is therefore advisable to depress the brake pedal slightly to illuminate the brake lights.

pg. 55 Driving economy, Shift indicator light

Economical driving does not necessarily mean driving slowly

Better driving economy may be obtained by thinking ahead, avoiding rapid starts and stops and adjusting the speed of your vehicle to immediate traffic conditions. Observe the following rules:

- Bring the engine to normal operating temperature as soon as possible by driving with a light foot on the accelerator pedal instead of allowing the engine to idle for a prolonged period. A cold engine uses more fuel and is subject to increased wear.
- Drive carefully and avoid rapid acceleration and hard braking.
- Do not exceed speed limit.
- Avoid carrying unnecessary items (extra load) in the car.
- Check tire pressures regularly (cold tires).
- Remove snow tires when threat of snow or ice has ended.

- Note that roof racks, ski racks, etc., increase air resistance and thereby fuel consumption.
- Avoid using automatic transmission kickdown feature unless necessary.
- Avoid using the air conditioning when it is not required.

Other factors which decrease gas mileage are:

- Low tire pressure
- Worn or dirty spark plugs
- Incorrect spark plug gap
- Dirty air filter
- Incorrect valve clearance
- Dirty engine oil and clogged oil filter
- Dragging brakes
- Incorrect front end alignment

Shift indicator light

(manual transmission models only)

The Volvo shift indicator light (S.I.L.) is a device designed to help you get even better gas mileage from your Volvo car. Studies have shown that the best fuel economy is obtained by shifting gears at low engine rpm and high relative engine load. The Volvo S.I.L. is calibrated to show you when to shift for improved mileage without sacrificing smooth acceleration.

Use of the S.I.L. is simple. Shift to next higher gear as soon as the light comes on. You may find after using the S.I.L. for some time that your natural shifting rhythm will adapt to the S.I.L.'s suggestion. Some drivers may even shift before the light comes on.

Obviously, there will be times when you need to shift later than the light would indicate (for example, when climbing hills or trailer towing). Using the light regularly, however, should result in mileage improvement of six percent or more, depending on how you normally drive.

Programming instructions for shift indicator

If the current supply to the control module is cut (battery disconnected), the control module will have to be re-programmed as its memory will be erased.

Drive the car in each gear (first gear not necessary) for approximately 8 seconds.

The gear change indicator light will flicker once (0.5 seconds), as each gear is programmed.

Note: Remove foot completely from the clutch pedal after each gear change when programming the control module.

Starting and stopping

1. Fasten the seat belt.

WARNING! Before starting, check that the seat is adjusted properly. Make sure the brake pedal can be depressed completely. Move the seat closer if necessary. Refer to section "Front seats".

2. Apply the parking brake, if not already set. The gear selector (automatic transmission n) is locked in the (P)ark position (SHIFT LOCK).
3. Without touching the accelerator pedal , (depress the clutch pedal - manual transmissions), turn the ignition key to the starting position. Allow the starter to operate for up to 5 seconds. Release the key as soon as the engine starts. If the engine fails to start, repeat step 3.
For cold starts at altitudes above 6000 ft (1800 meters), depress the accelerator pedal halfway and turn the key to the starting position. Release the accelerator pedal slowly when the engine starts.
4. To release the gear selector from the (P)ark position (automatic transmission) the ignition key must be in position II and the brake pedal must be depressed.

See page 107 for instructions on manually overriding the SHIFTLOCK system if the lever cannot be moved.

Do not race a cold engine immediately after starting. Oil flow may not reach some lubricating points fast enough to prevent damage.

NOTE: (automatic transmissions only)

Your car is equipped with a KEYLOCK system. When the engine is switched off, the gear selector must be in the (P)ark position before the key can be removed from the ignition switch.

Engine warm-up - initial driving procedure

Experience shows that engines in vehicles driven short distances are subject to abnormally rapid wear because the engine never reaches normal operating temperature. It is therefore beneficial to reach normal operating temperature as soon as possible by driving with a light foot on the accelerator pedal.

Warning : Before starting the engine inside a garage, always open the garage doors fully to ensure adequate ventilation. Exhaust gases contain carbon monoxide, which is invisible and odorless but very poisonous.



[Contents](#) | [Top of Page](#)



5-speed manual transmission

Depress the clutch pedal fully when changing gears.

Remove the foot from the clutch pedal after every gear shift.

See "Shift indicator light" section for more information on economical use of the manual transmission.

Recommended minimum and maximum speeds for each gear are listed in the specification section.

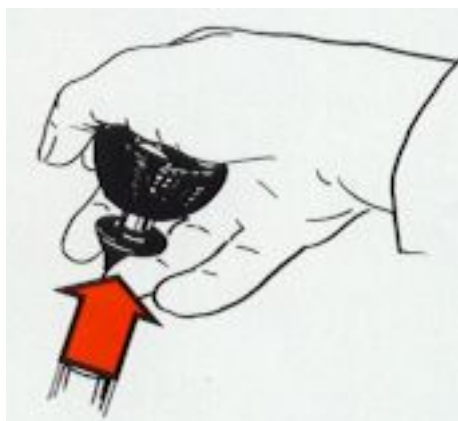

Reverse gear (R)

The detent collar on the gear shift lever prevents inadvertent selection of reverse gear. The collar must be lifted to engage reverse gear.

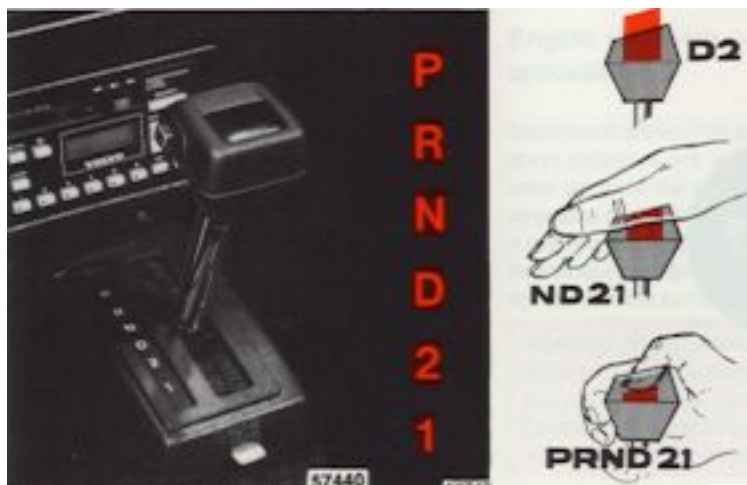

Shift positions

P park D drive

R reverse 2 intermediate

N neutral 1 low

The gear selector can be moved freely between D and 2. Selections of other positions are obtained by depressing the selector knob prior to moving the selector.

Depressing the selector knob slightly allows selection of positions N and 1 .

Depressing the selector knob fully allows selection of positions R and P.

The gear lever is blocked in the P position. In order to move the gear selector lever from position P, the ignition must be switched on (ignition key in position II) and the brake pedal has to be depressed.

- Depress the brake pedal
- Select a gear
- Release the brake pedal

P Park

Use this position when parked with the engine running or stopped. Never use P while car is in motion.

The transmission is mechanically locked in position P. Also use the parking brake when parking on grades for added safety.

The gear lever is blocked in position P. In order to move the gear lever out of position P, you have to first switch on the ignition and then depress the brake pedal (manually releasing see page 107).

R Reverse

Never use R while car is moving forward.

N Neutral

Neutral position = no gear is engaged. Use parking brake. The car can also be started in this position.

D Drive

D is the normal driving position. Upshift and downshift of the forward gears occurs automatically and is governed by acceleration and vehicle speed.

2 Intermediate position

Upshift and downshift of first two gears (low and intermediate) occurs automatically. No upshift to 3rd (top) gear occurs.

Position 2 may be used to obtain forced downshift to 2nd gear for increased engine braking effect.

Position 2 can also be used.....

- for relatively slow highway driving.
- for city driving.
- when driving on mountain road where precise speed control is desirable.
- for passing.

1 Low position

If position 1 is selected when driving at high speeds. 2 is engaged first and 1 when the speed has dropped approx. 30 mph (50 km/h).

NOTE: No upshift once 1 is engaged.

Use position 1 to select low gear with no upshift. Use for instance, when ascending and descending steep grades.

pg. 59 Automatic transmission



Button on gear selector knob and indicator light symbol.

Disengaging 4th gear

The transmission will engage 4th gear automatically after upshifting through first, second and third gears unless disengagement button on the side of the gear knob is pushed.

When the button is pushed to disengage 4th gear, the transmission operates as a 3-speed unit. If the button is pushed while 4th gear is engaged, then a downshift to 3rd gear will occur. The transmission then, cannot upshift to 4th gear until the button is pushed again. As a reminder, when 4th gear is disengaged, the indicator light in the instrument panel is illuminated.

Be aware that, if 4th gear is disengaged (reminder light illuminated) when the engine is switched off, the transmission will revert automatically to 4-speed operation (reminder light not illuminated) when the engine is restarted.

Disengage 4th gear (reminder light illuminated) when:

- towing a trailer
- driving on hilly roads where precise speed control is desired.

CAUTION:

- Never select P or R while the car is in motion.
 - When initially selecting D, 2, 1 or R, your right foot should press firmly on the brake and the engine must be idling.
 - Never downshift to 2 or 1 at speeds above 75mph (125km/h)*.
- * Always observe local speed limits!

Kick-down

Automatic down-shift to lower gear is achieved by depressing the accelerator pedal fully and briskly. An up-shift will be achieved when approaching the top speed for a particular gear or by releasing the accelerator pedal slightly.

Kick-down can be used for maximum acceleration or when passing at highway speeds.

pg. 60 Automatic Transmission

Starting and stopping a car equipped with automatic transmission

1. Enter the car and check that the seat is adjusted properly. Make sure that the brake pedal can be depressed completely. Move the seat closer if necessary.
2. Fasten the seat belt.
3. Apply the parking brake if not already set.
4. Place the gear selector in Park (or neutral).
5. Start the engine in the usual manner. The gear selector is locked in the Park position. The brake pedal must be depressed to release the gear selector.
6. Select the desired gear. There is a slight delay before the gear engages which is most notable when selecting Reverse. Do not accelerate until you have felt the gear engage!

Note: Too-rapid acceleration immediately after selecting a gear will cause harsh engagement and premature transmission wear.

7. Release parking brake, then foot brake, and accelerate. To stop the car release the accelerator pedal and apply the brakes with your right foot.

It is not necessary to move the gear selector as the transmission will downshift automatically. When idling for extended periods of time, select position N to prevent unnecessary heating of the transmission.

WARNING! Always place gear selector in Park and apply parking brake before leaving vehicle. Never leave car unattended with engine running.



[Contents](#) | [Top of Page](#)

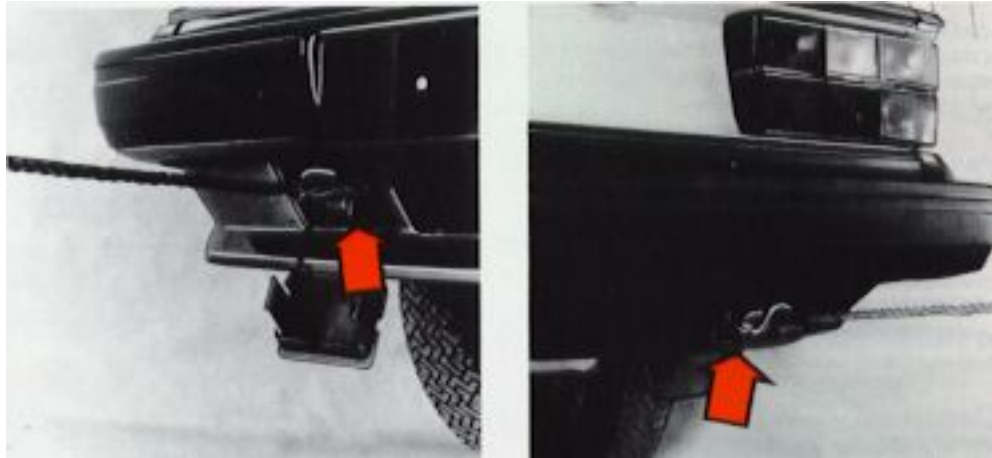

Front eyelet Rear eyelet

Precautionary steps to observe when towing

Please check with state and local authorities before attempting this type of towing as vehicles being towed are subject to regulations regarding maximum towing speed, length and type of towing device, lighting, etc.

- Steering must be unlocked.
- Remember that power brake and power steering assist will not be available when engine is inoperative. Pedal pressure required is 3-4 times above normal and greater steering effort must be exerted.
- Towing cars equipped with automatic transmission:
 - Gear selector in position N. Check transmission oil level (see section titled "Transmission oil")
 - Maximum speed: 20mph (30km/h)
 - Maximum distance with rear wheels on ground: 20 miles (30 km).
- If the car's batter is dead, it is not possible to move the gear lever out of position P simply by pressing the brake pedal. The gear lever has to be released manually by moving to the left the lever under the cover panel. See page 107.

Only use wheel lift or flat bed equipment.

CAUTION:

Sling-type equipment applied at the front will damage radiator and air conditioning lines. It is equally important not to use sling-type equipment at the rear or apply lifting equipment inside the rear wheels; serious damage to the rear axle may result.

Jump starting, see section titled "Generator, jump starting".

NOTE: Refer to the section regarding "On-call"

CAUTION!

Do not attempt to start the car by pushing or pulling as damage to the three-way catalytic converter can result.

pg. 62 Trailer hauling

When preparing for trailer hauling, observe the following:

- Use a trailer hitch which meets Federal Safety Standards for rear end collisions (FMVSS 301-75). For trailer weights exceeding 2,000 lbs (908 kgs) use only a trailer hitch offered as a Genuine Volvo Accessory.

- Maximum trailer weight recommended by Volvo is : Trailers without brakes: 1540 lbs (700 kg). Trailers with brakes: 2" ball - 3300 lbs (1500 kg), 1 7/8" ball - 2000lbs (908 kg).

However, for cars with automatic transmission, an optional Volvo automatic transmission oil cooler must be installed when trailer weight exceeds 2,000 lbs (908 kgs). With manual transmission, 5th gear should not be used while towing. Observe legal requirements of the state in which the vehicles are registered.

All Volvo models are equipped with energy absorbing shock mounted bumpers. Trailer hitch installation should not interfere with the proper operation of the bumper system.

WARNING! Bumper-attached trailer hitches must not be used on Volvo's, nor should safety chains be attached to the bumper.

Trailer hitches attaching to the vehicle rear axle must not be used.

Never connect a trailer's hydraulic brake system directly to the vehicle brake system, nor a trailers lighting system directly to the vehicle lighting system directly to the vehicle lighting system. Consult your nearest authorized Volvo dealer for correct installation.

Trailer hauling does not normally present any particular problems, but take into consideration:

- Recommended hitch tongue load is 110 lbs (50 kgs) for trailer weights below 2,650 lbs (1,200 kgs) and 143-154 lbs (65-70 kgs) for trailer weights above 2,650 lbs (1,200 kgs). However, it must not exceed 165lbs (75kgs).

- For trailer weights between 2,650 -3,300 lbs (1,200-1,500 kgs) a top speed of 50mph (80km/h) should never be exceeded.
- Engine and transmission are subject to increased loads. Therefore, engine coolant temperature should be closely watched when driving in hot climate or hilly terrain. Use lower gear and turn off air conditioner if temperature gauge pointer enters the red range.
- Avoid overload and other abusive operation.
- Hauling a trailer affects handling, durability and economy.
- It is necessary to balance trailer brakes with the towing vehicle brakes to provide a safe stop (check and observe State regulations).
- More frequent vehicle maintenance is required.
- Remove the ball and drawbar assembly when the hitch is not being used.
- Increase tire pressure to recommended full load pressure. See section "Wheels and Tires".
- Volvo recommends the use of synthetic engine oil when towing a trailer over long distances or in mountainous areas.
- The trailer hitch tongue load (110/165 lbs - 50/75 kg) is part of the vehicle's capacity weight. It may be necessary to reduce the trunk/cargo area load when towing a trailer to ensure that the max. permissible axle load or gross vehicle weight are not exceeded.

Note: Refer to section entitled "Automatic transmission" for additional trailer hauling tips.

Warning: Do not drive with trunk lid or tailgate open!

Poisonous exhaust gases may enter via the open trunk lid or tailgate. (This is especially true for wagon models.)

If the trunk lid or tailgate for any reason must be open, proceed as follows:

- Close the windows.
- Set the heating system controls for floor and defroster to max. and the blower to full speed (4). See section titles "Heating and Ventilation".
- The recirculation button must not be depressed.

Roof rack

Permanent and removable roof racks are available from Volvo Accessories.

Observe the following points when in use:

- Avoid point loads. Distribute the load evenly.
- Place the heavy cargo at bottom of load.
- Observe that center of gravity and handling are influenced by the load weight.
- Increasing load size increases wind resistance.
- Anchor the cargo correctly with a cord.

- Drive carefully. Avoid rapid starts, heavy cornering and heavy braking.
- Permanent roof rack load limit: 110 lbs (50kg).
- Load bar load limit: 220 lbs. (100 kg)
- Max. roof load is 220 lbs (100 kg) including the roof rack. Use a roof rack with a sufficient load rating.

pg. 63 Automatic transmission

The following "Special Tips" apply to cars with automatic transmission

- For steep hills and when driving for prolonged periods at low speeds, position 1 should be selected. Avoid, however, repeated changes since this can cause overheating of the transmission oil. For driving on mountain roads with long persistent uphill gradients, select position 2.
- When negotiating long steep, downhill slopes, position 1 should be selected and position 2 for less severe inclines, in order to obtain the best possible engine braking effect.
- Do not hold the car stationary on an incline by using the accelerator pedal. Instead, engage the handbrake this prevents the transmission oil from becoming overheated.
- 4th gear must be disengaged when hauling a trailer!
- If an additional transmission oil cooler is installed you can haul a trailer with the overdrive engaged. See next "special tip".
- When driving with heavy trailers, it is recommended that an additional oil cooler be installed. This applies especially when driving under severe conditions e.g. mountain driving or prolonged driving at high speeds without breaks. The additional oil cooler is available as a genuine Volvo accessory. Regarding oil change, see section titled "Transmission oil".

Brake system

Moisture on brake discs and brake pads affects braking

Driving in rain and slush or passing through a normal car wash can cause water to collect on the brake discs and pads. This will cause a delay in braking effect when the pedal is depressed. To avoid such a delay, when brakes are needed, depress the pedal occasionally when driving in rain or slush. This will remove the water from the brakes. This should also be done after washing or starting in very damp weather.

If the brake power assist does not function-

The power assist to the brakes functions only when the engine is running. When the car is moving without the engine running the brake pedal pressure required to stop the car is increased 3-4 times. The brake pedal feels stiff and hard.

Disc brake noise: A slight-to-moderate amount of disc brake "squeal" is considered normal.

Air dam (front spoiler)

A non-factory air dam can negatively influence the normal flow of cooling air in the front wheel brakes. (See section titled "Wheels and Tires").



If one of the brake circuits should malfunction the red warning light will come on

The pedal stroke increases slightly, the pedal feels softer and extra pressure is required for normal braking. If the light comes on while driving or braking, stop immediately and check the brake fluid level in the reservoir.

WARNING!

If the fluid level is below the MIN mark in either section of the reservoir: **DO NOT DRIVE**. Tow the car to a volvo dealer, have the brake system checked and any leakage repaired.

Severe strain on the brake system

The brakes will be subject to severe strain when driving in mountains or hilly areas. The speed is usually low which means that the cooling of the brake is less efficient than when driving on level roads.

To reduce the strain on the brakes it is advisable not to use the brakes excessively. Instead, shift into a lower gear and let the engine help with the braking. A good rule is to use the same gear downhill as would be used ascending the same grade. For vehicles with automatic transmission use position 2, or in some cases 1.

pg. 64 Three-way catalytic (TWC) converter

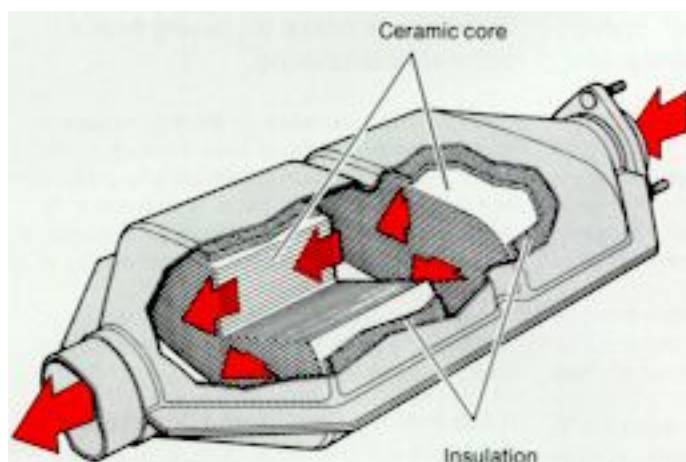

Three-way catalytic converter Cautions

- Keep your engine properly tuned. Certain engine malfunctions, particularly involving the electrical, fuel or distributor ignition systems, may cause unusually high converter temperatures. Do not continue to operate your vehicle if you detect engine misfire, noticeable loss of power or other unusual operating conditions, such as engine overheating or backfiring. A properly-tuned engine will help in avoiding malfunctions that could damage the three way catalytic converter.

CAUTION: Unleaded fuel is required for cars with three-way catalytic converter. A label on the instrument panel inside the fuel filler door will remind owners and filling station attendants of this requirement.

Important! It is unlawful to dispense leaded fuel into any vehicle labeled "unleaded gasoline only".

WARNING: Do not park your car over combustible materials, such as grass or leaves, which can come into contact with the hot exhaust system and cause such materials to ignite under certain wind and weather conditions.

- Excessive starter cranking (in excess of one continuous minute) with an intermittently firing or flooded engine, can cause TWC converter or exhaust system overheating. This also applies to lengthy pushing or towing of vehicle to start (manual transmissions only). Do not attempt to start a car with automatic transmission by pushing or towing.



[Contents](#) | [Top of Page](#)

Subject	Page
Maintenance services	67
Service requirements	68
Engine B230F	70
Fuel requirements	71
Engine fluids	73
Engine oil, Oil/oil filter change interval	74
Cooling system	75
Servicing	77
Transmission oil	82
Rear axle, power steering, brake fluid	84
Lubrication	85
Coolant	86
Generator, jump starting	87
Replacing bulbs	88
Fuses	93
Wheels and tires	94
Wheel changing	96
Replacing wiper blades	98
Washing	98
Cleaning, anti-rust treatment	99
Paint touch-up	100
What causes rust	102
Long distance trips, cold weather	103
Service diagnosis	104
Label information	108



pg. 67 Maintenance service

Maintenance inspection intervals

Volvo advises you to follow the inspection program at 10,000 mile or 16,000 km intervals which is outlined in the "Maintenance Records Booklet". This maintenance program contains inspections and services necessary for the proper functioning of your car over the next inspection interval.

The maintenance inspections contain several checks which require special instruments and tools and therefore must be performed by a qualified technician.

To keep your Volvo in top condition, specify time tested and proven Genuine Volvo Parts and Accessories.

The Federal Clean Air Act (USA)

The Clean Air Act requires vehicle manufacturers to furnish written instructions to the ultimate purchaser to assure the proper functioning of those components that control emissions.

The maintenance instructions listed in the "Servicing" section of this Manual represent the minimum maintenance required. These services are not covered by the warranty. You will be required to pay for labor and material used. Refer to your "Maintenance Records Booklet" for further details.

Maintenance services

Your Volvo has passed several major inspections before being delivered to you, according to Volvo specifications. The maintenance services outlined in this book should be performed every 10,000 (16,000 km). The extended maintenance service intervals make it even more advisable to follow this program inspection and service should also be performed any time a malfunction is observed or suspected.

It is recommended that receipts for vehicle emission services be retained in the event that questions arise

concerning maintenance. See your "Maintenance Records Manual".

Applicable warranties - U.S.

In accordance with U. S. Federal Regulations, the following list of applicable U.S. warranties is provided. For Canadian specification vehicles, see your separate warranty booklet.

- New Car Limited Warranty
- Parts and Accessory Limited Warranty
- Corrosion Protection Limited Warranty
- Seatbelt and Supplemental Restraint System Limited Warranty
- Emission Design and Defect Warranty
- Emission Performance Warranty

These are Federal Warranties; other warranties are provided as required by state law.

Refer to your separate Warranty Booklet for detailed information concerning each of the warranties.

pg. 68 Servicing

MAINTENANCE SCHEDULE

A = Adjust (Correct if necessary)

R = Replace

I = Inspect (Correct or Replace if necessary)

L = Lubricate

Maintenance operation Miles (km)	10,000 (16,000)	20,000 (32,000)	30,000 (48,000)	40,000 (64,000)	50,000 (80,000)	60,000 (96,000)
EMISSIONS SYSTEM MAINTENANCE						
Engine oil and oil filter	R	R	R	R	R	R
Engine drive belts			I			I
Valve clearance			I			I
Timing belt	A				R (3)	A
Air cleaner filter			R			R
Spark plugs			R			R

Manual transmission oil	I	I	I	I	I	I
Automatic transmission oil	I	R	I	R	I	R
Rear axle oil	I	I	I	I	I	I

- 1) See section "Engine Oil" for detailed information.
- 2) For services beyond 60,000 miles (96,000 km), consult your Maintenance Service Chart.
- 3) B 230 FD only: Adjust at 10,000 miles (16,000 km) - no cost to owner. Belt should be replaced at 100,000 miles (160,000 km).

pg. 69 Servicing						
Maintenance operation Miles (km)	10,000 (16,000)	20,000 (32,000)	30,000 (48,000)	40,000 (64,000)	50,000 (80,000)	60,000 (96,000)
MISCELLANEOUS MAINTENANCE						
ENGINE						
Fuel (line) filter						R
PCV nipple (orifice)						I
Ventilation hoses						I
EGR valve						I
Battery charge	I	I	I	I	I	I
BRAKES						
Inspect brakes, replace components as necessary	I	I	I	I	I	I
Change Brake Fluid			R			R
STEERING						
Tire wear (align front end if needed)	I	I	I	I	I	I
Check power steering fluid level	I	I	I	I	I	I
BODY						
Trunk, hood hinges and latches	L	L	L	L	L	L

- 1) For services beyond 60,000 miles (96,000 km), consult your "Maintenance Service Chart".
- 2) 30,000 miles (48,000 km) or every two years.
- 3) B 230 FD only: Clean at 100,00 miles (160,000 km).
- 4) B 230 FD only: Recommended but not required to maintain Volvo Emission Warranty.

pg. 70 Servicing Engine

The following items should be checked weekly by the owner. (This only takes a few moments.)	Description on page
Engine Oil Level	73
Brake Fluid	84
Radiator coolant level	86
Tire Pressure (including spare)	94 , 115
Operation of all lights	-
Horns	-
Windshield wipers	-
Level of windshield fluid	-

The following should also be carried out at regular intervals.

[Washing, 99](#)

[Polishing, 99](#)

[Cleaning, 99](#)

[Rust protection inspection, 99](#)

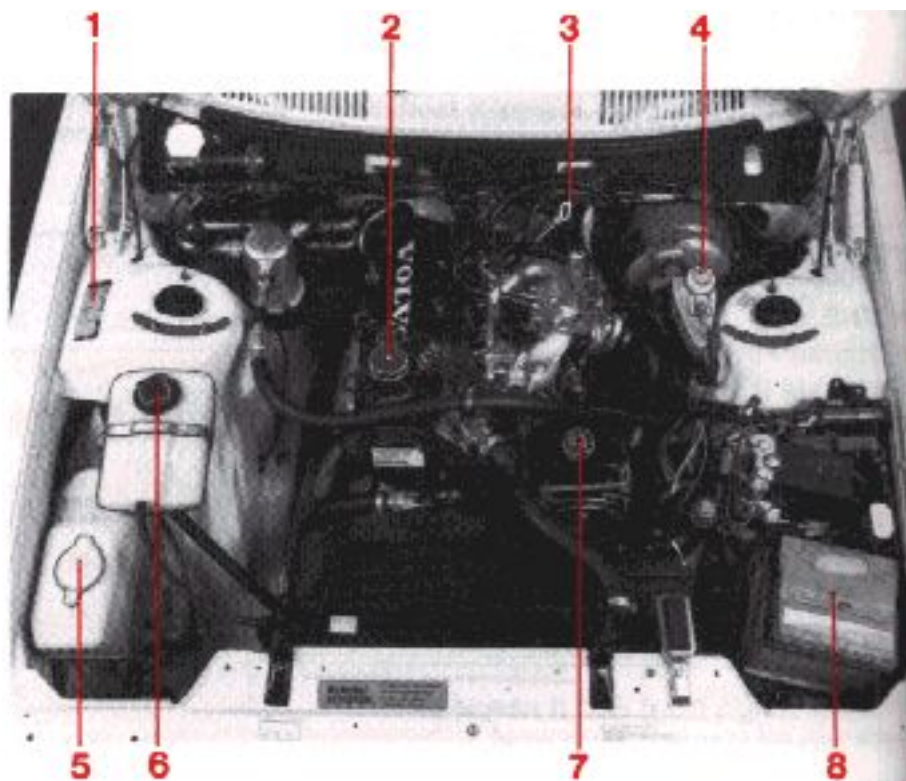

Engine B230F

- 1 Data plate
- 2 Oil filler cap, engine
- 3 Oil dipstick, engine
- 4 Brake fluid reservoir
- 5 Washer fluid
- 6 Expansion tank, coolant
- 7 Oil reservoir, power steering
- 8 Battery



[Contents](#) | [Top of Page](#)

pg. 7 Before you drive:

Instruments and controls	8
Instruments	10
Warning lights	11
Clock	12
Oil pressure gauge, voltmeter	13
Ignition switch, turn signals	14
Lighting	15
Windshield wipers, washer nozzles	16
Cruise control	17
Washer fluid reservoir	18
Rear window demister, hazard warning flasher	18
Parking brake, heated seat	19
Cigarette lighter, ash trays	20
Electrically operated windows	21
Heating and ventilation	22
Air conditioning	24
Audio systems	25
Occupant safety	37
Child safety	38
Seat belts	40
SRS (Supplemental Restraint System)	42
Doors and locks	44
Trunk lid	45
Hood release, long load storage	46
Rear/side view mirrors	47
Interior light, sun roof, fuel tank cap	48
Rear seat (wagon)	49
Tailgate (wagon)	50
Cargo compartment (wagon)	51
Front seats	52

pg. 8 Instruments and controls

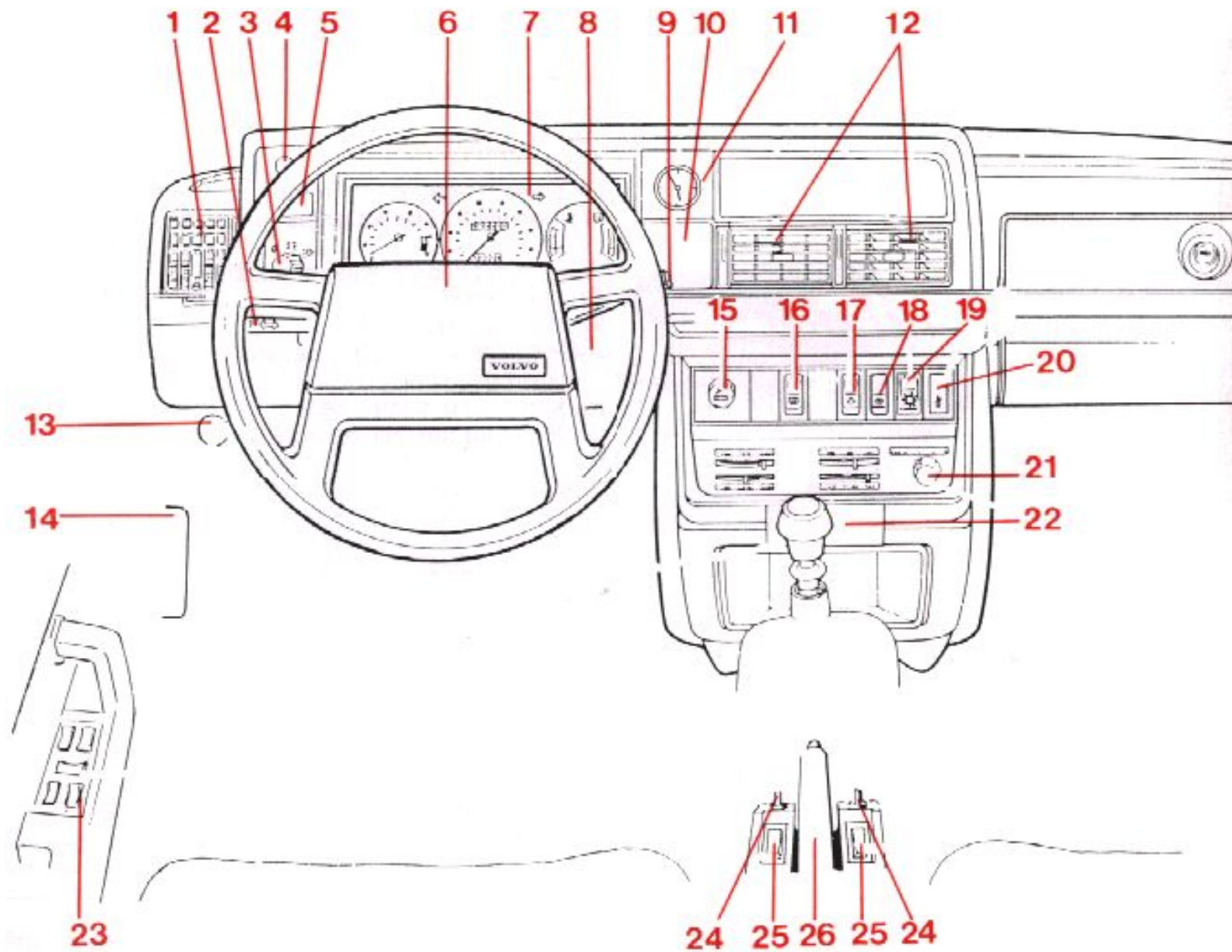

pg. 9 Instruments and Controls

<u>No.</u>	<u>Item</u>	<u>Page No.</u>
1	Air louver	23
2	Turn signals, cruise control	14 , 17
3	Headlights, parking lights	15
4	Instrument panel rheostat	15
5	Rear fog light	15
6	Horn	--
7	Instrument panel	10
8	Starting (ignition) switch/steering wheel lock	14
9	Wiper/washer, tailgate window wiper/washer (wagon)	16
10	Space for optional equipment	--

11	Clock	13
12	Air louver	23
13	Hood release handle	46
14	Fuse box	93
15	Cigarette lighter	20
16	Rear window demister	18
17	Hazard warning flashers	18
18	Heated door mirrors (certain models only)	19
19	Air conditioning compressor switch	24
20	Seat belt reminder light	40
21	Blower motor switch	22
22	Ash tray	20
23	Electrically operated windows (certain models only)	21
24	Control for electrically operated side mirrors (certain models only)	47
25	Seat heaters (optional)	19
26	Parking brake	19

The pages in this section provide a detailed description of the vehicle's instruments and controls. Note that some vehicles may be equipped differently, depending on model, special legal requirements, etc.

pg. 10 Instruments

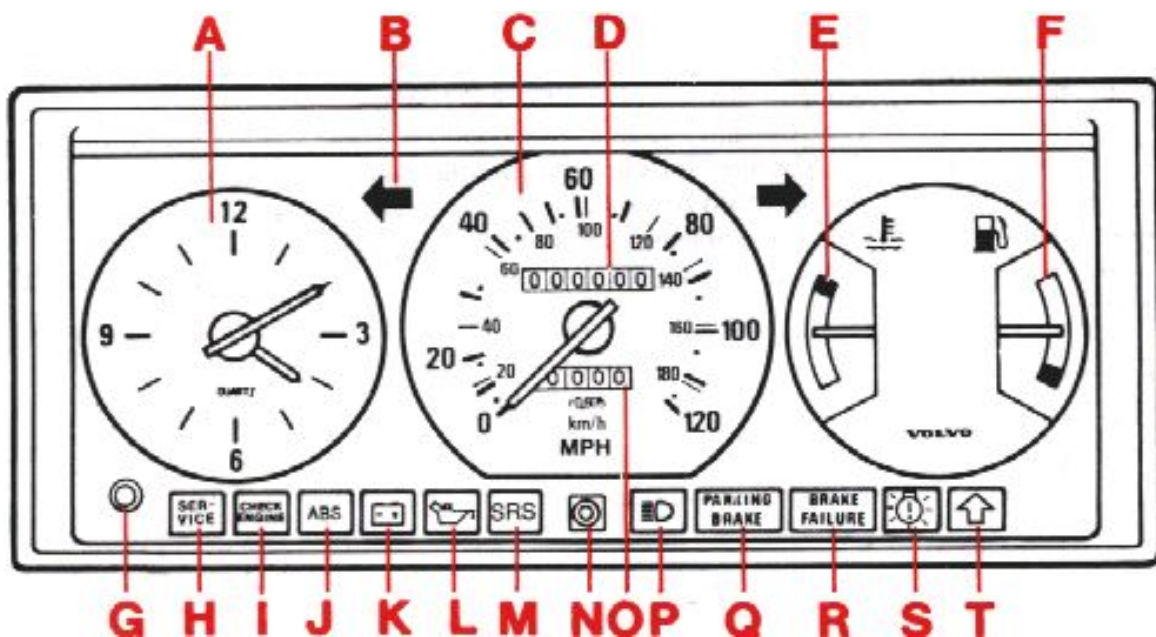

A Clock

B Direction indicator (green)

C Speedometer

In kilometer and miles per hour (U.S. models)

In kilometers per hour (Canadian models)

D Odometer

Total reading in miles (U.S. models)

Total reading in kilometers (Canadian models)

E Temperature gauge

The gauge pointer should remain inside the black range during normal operation. If the pointer enters the red range repeatedly, check coolant level and fan belt tension. (See sections titled "Cooling system and coolant")



Warning: allow engine to cool before adding fluid.

Do not continue to drive the car with the pointer in the red zone.

F Fuel gauge

The fuel tank capacity is approx 60 liters=15.8 US gals. See "Fuel requirements"

G Clock reset knob

H Service reminder indicator

I Malfunction indicator lamp

J ABS-system (yellow)

K Generator warning light (red)

L Oil pressure warning light (red)

Do not drive the car with this light on.

M SRS (Supplemental Restraint System)

N Trip odometer reset knob

O Trip odometer

P High beam indicator (blue)

Q Parking brake reminder light (red)

R Brake failure warning light (red)

S Bulb failure warning light (yellow)

T Overdrive OFF indicator light (yellow)

(automatic transmission models)

Shift indicator light (yellow)

(manual transmission models)

pg. 11 Warning lights

The warning lights described on this page should never be on when driving

When the ignition is turned on, and before the engine starts, all of the warning lights should be on to test the function of the bulbs. Should a light not go off after the engine has started, the systems indicated should be inspected. However, the parking brake reminder light will not go off until the parking brake is fully released.



Generator warning light (red)

If the light comes on while the engine is running, check the tension of the generator drive belt as soon as possible. (See section titled "Cooling system".)

NOTE: This warning light is illuminated if the generator is not charging. However, generator, parking brake, brake failure, and bulb failure will be illuminated at the same time due to the design of the system.



Oil pressure warning light (red)

If the light comes on while driving, the oil pressure is too low. Stop the car and then stop the engine immediately and check the engine oil level. If the light stays on after restart, have the car towed to the nearest authorized Volvo dealer. See section titled "Engine Oil". After hard driving, the light may come on occasionally when the engine is idling. This is normal, provided it goes off when the engine speed is increased.



Parking brake reminder light (red)

This light will be on when the parking brake (hand brake) is applied. The parking brake lever is situated between the front seats. Canadian models are equipped with this warning light: 



Brake fluid warning light (red)

If the light comes on while driving or braking, this indicates that the brake fluid level is too low. Stop immediately, open the hood and check the brake fluid level in the reservoir (see section "Engine compartment" for reservoir position)!

Canadian models are equipped with this warning light: 

Warning!

If the fluid level is below the MIN mark in either section of the reservoir, **DO NOT DRIVE**. Tow the car to a Volvo dealer, have the brake system check and any leakage repaired.



Malfunction indicator lamp

If this lamp comes on (or stays on after the vehicle has started), the engine diagnostic system has detected a possible fault in the emission controls. Although driveability may not be affected, see an authorized Volvo dealer as soon as possible for inspection.

pg. 12 Warning Lights



Supplemental Restraint System (SRS)

If the light comes on (or stays on after the vehicle has started), the SRS diagnostic system has detected a fault. Drive to an authorized Volvo dealer for an inspection of the system. See the SRS section for more information.



Service reminder indicator

This light will come on at approx. 10,000 mile (16,000 km) intervals. It is a reminder to the driver that the 10,000 mile (16,000 km) service interval has been exceeded. The light will stay on 2 minutes after starting until reset by the

servicing dealer.



Bulb failure warning light (amber)

The light will come on if any of the following bulbs are defective:

one of the lower beams

one of the tail lights

one of the brake lights (when the brake pedal is depressed).

See section on "Replacing Bulbs".



Anti-lock Brake System (ABS)

If the warning lamp lights up there is a malfunction of the ABS system (the standard braking system will however function) and the vehicle should be driven to a Volvo dealer for inspection.

The Anti-lock Braking System (ABS) helps to improve vehicle control (stopping and steering) during severe braking conditions by limiting brake lock-up. When the system "senses" impending lock-up, braking pressure is automatically modulated in order to help prevent lock-up, which could lead to a skid. The system performs a self-diagnostic test when the vehicle is started and at 4 mph (6km/h) during which the driver may detect one pulsations of the brake pedal. This is normal.

To obtain optimal effect from the ABS system, constant pressure should be kept on the brake pedal while the system is modulating the brakes.

The switching of the ABS modulator will be audible at this time.

Please be aware that ABS does not increase the absolute braking potential of this vehicle. While control will be enhanced, ABS will not shorten stopping distances on slippery surfaces.

pg. 13 Oil pressure gauge, Voltmeter



Quartz crystal clock

To reset the hands, push the reset knob and turn.

Oil pressure gauge



Oil Pressure gauge (optional)

The oil pressure gauge indicates the pressure of the oil in the lubricating system of the engine. The pressure is dependent on the speed of the engine, the oil temperature and the viscosity of the oil. 1 bar = approx. 14 psi. The gauge pointer must not go down to the red field while driving. Do not continue to drive the car with the pointer in the red zone.

Note: While idling with a hot engine the pointer may go into the red field. This is not a cause for concern providing the pointer rises to the normal driving range again when you increase the engine speed.

Voltmeter

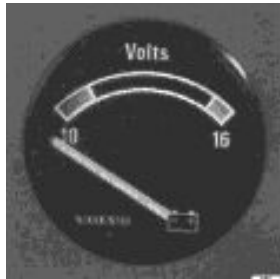

Voltmeter (optional)

The voltmeter indicates the voltage in the electrical system and thereby also the state of the battery. While the car is being driven the pointer should be within the black field. Should the pointer point to the upper or lower red field when driving, this may indicate some fault in the electrical system.

Note: While idling with a hot engine (especially with air conditioning ON), the pointer may indicate low voltage. This is not a cause for concern provided that the indicated voltage increases when you increase engine speed.



[Contents](#) | [Top of Page](#)

Unleaded Fuel

Each Volvo has a three-way catalytic converter and must use only unleaded gasoline (as specified on the instrument panel and inside the fuel filler door). U.S. and Canadian regulations require that pumps delivering unleaded gasoline be labelled "UNLEADED". Only these pumps have nozzles which fit your car's filler inlet. It is unlawful to dispense leaded fuel into a vehicle labelled "unleaded gasoline only". Leaded gasoline damages the three-way catalytic converter and the heated oxygen sensor system. Repeated use of leaded gasoline will lessen the effectiveness of the emission control system and could result in loss of emission warranty coverage. State and local vehicle inspection programs will make detection of misfueling easier, possibly resulting in emission test failure for misfueled vehicles.

Octane Rating

Volvo engines are designed for optimum performance on unleaded premium gasoline with an octane rating, AKI, of 91, or above. AKI, (ANTI KNOCK INDEX), is an average of the Research Octane Number, RON, the Motor Octane Number, MON, $(RON + MON)/2$. The minimum octane requirement is AKI 87 (RON 91).

Gasoline Containing Alcohol and Ethers

"Oxygenated fuels"

Some fuel suppliers sell gasoline containing "oxygenates" which are usually alcohols or ethers. In some areas, state or local laws require that the service pump be marked indicating use of alcohols or ethers. However, there are areas in which the pumps are unmarked. If you are not sure whether there is alcohol or ethers in the gasoline you buy, check with the service station operator. To meet seasonal air quality restrictions, some states require the use of "oxygenated" fuel in certain areas.

Volvo allows the use of the following "oxygenated" fuels; however, the octane ratings listed on this page must still be met.

Alcohol

Fuels containing up to 10% ethanol by volume may be used.

Ethanol may also be referred to as Ethyl alcohol or "Gasohol".

Methanol blends containing up to 3% methanol and 2% cosolvent can be used without damaging the fuel system or the engine if the octane rating, AKI, is 91 or higher. However, performance and fuel consumption might deteriorate on alcohol blends.

Ethers

Fuel containing up to 15% MTBE may be used.

Refueling

The fuel tank filler cap is located behind the door on the right rear fender. Open cap slowly during hot weather conditions.

When filling, position the cap in the special bracket on the door.

After filling the tank, install the cap and turn until a "click" is heard.

The fuel tank is designed to hold approximately 15.8 US gal. (60 liters), with sufficient volume left over to accommodate possible expansion of the fuel in hot weather.

Be aware that the "usable" tank capacity will be somewhat less than the 15.8-US gal. (60liter) maximum. When the fuel level is low, such factors as ambient temperature, the fuel's "vapor pressure" characteristics, and terrain can affect the fuel pumps' ability to supply the engine with an adequate supply of fuel. Therefore, it is advisable to refuel as soon as possible when the needle nears the red zone.

Caution: Take care not to spill gasoline during refueling.

Gasoline containing alcohol can cause damage to painted surfaces, which may not be covered under the New Vehicle Limited Warranty.

Do not use gasolines containing methanol (methyl alcohol, wood alcohol). This practice can result in vehicle performance deterioration and can damage critical parts in the fuel system. Such damage may not be covered under the New Vehicle Limited Warranty.

pg. 72 Carbon deposits

Deposit control gasoline

Volvo recommends the use of gasoline containing deposit control additives. These additives have shown to be efficient in keeping injectors and intake valves clean.

Consistent use of deposit control gasolines will ensure good driveability and fuel economy. If you are not sure whether the gasoline contains deposit control additives, check with the service station operator.

Note:

Do not add additives yourself to the gasoline, unless you are recommended to do so by an authorized Volvo dealer.

If you change the engine oil and filter yourself, your Volvo dealer can assist you in disposing of the used oil. Engine oil can be harmful to your skin - gloves should be worn when performing this work.

PROTECT THE ENVIRONMENT

It is illegal to pollute drains, water courses and soil. Use authorized waste collection facilities, including approved recycling centers and garages providing facilities for disposal of used oil and oil filters. If in doubt, contact your local authority for advice on disposal.

pg. 73 Engine Fluids



Checking oil level

The oil level should be checked every time the care is refuelled. Be sure the oil level is maintained between the upper and lower marks on the dipstick. Low oil level can cause internal damage to the engine and overfilling can result in high oil consumption. The distance between the dipstick marks represents approx. 1 quart (1 liter) of oil.

Note: The engine must be stopped when checking oil.

Changing oil filter

Replace the oil filter at every oil change. If the oil filter is changed separately, 1/2 US qt = 1/2 liter of oil should be added.

To add oil or change oil

Add oil of the same kind already used. See engine oil section.

Note: Allow engine to cool before changing oil.

Coolant

Maintain fluid level between MAX and MIN marks on expansion tank. Mixture of 50 percent Volvo Original coolant/antifreeze or similar and 50 percent water should be used. See "Coolant" section.

Brake fluid

Without removing the cap, check that the level is above the MIN mark. Brake fluid DOT 4+. See "Brake fluid" section.

Battery

Check level in conjunction with normal service or once a year. Electrolyte level 1/4"-3/8" (5-10mm) above plates. Use distilled water. Never add acid .

Batteries contain corrosive and toxic acids. It is of the utmost importance that old batteries are disposed of correctly. Your Volvo dealer can assist you in this matter.

Warning:

Battery gases are explosive if brought in contact with open flame or sparks.

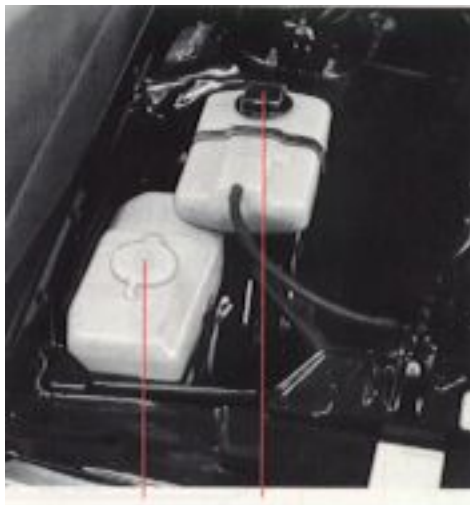

Washer fluid Coolant reservoir

Washer fluid

Washer fluid reservoir.

Water and solvent (in wintertime, use windshield washer anti-freeze). See "Washer fluid reservoir"

section.

pg. 74 Engine Oil, 10,000-mile (16,000-km) oil/oil filter change interval

Oil quality

Meeting API specification SG

Oil with designation SG/CD complies with this requirement.

Oil with a different quality rating may not provide adequate engine protection. For best fuel economy and engine protection, consult with your authorized Volvo dealer for recommended oils.

Viscosity (stable ambient temperatures):

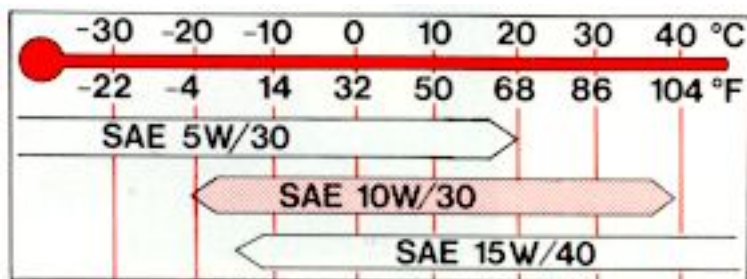

Do not use oils with other viscosity ratings. The use of incorrect viscosity oil can shorten engine life. Volvo recommends the used of energy-conserving oils. Look for the API label. Synthetic oils complying with oil quality requirements are recommended for driving in areas of sustained temperature extremes (hot or cold), when towing trailers over long distances or for prolonged driving in mountainous areas. Volvo does not recommend oil additives, as they can adversely affect the engine.



Volvo recommends the use of oils with the American Petroleum Institute (API) label. This label certifies that the oil conforms to the applicable standards and specifications of the API.

Capacity

Including oil filter: 4.0 US qts = 3.85 litres

Check oil level when filling fuel.

SAE 15W/40 is recommended for use in driving conditions that raise oil temperature and increase oil consumption. (i.e., mountain driving, trailer towing)

Note: SAE 15W/40 must not be used at low ambient temperatures; see viscosity chart.

Changing oil and oil filter

Oil and oil filter changes should be made as specified by this table.

If driving conditions include:	Then the correct oil/oil filter change interval is:
<ul style="list-style-type: none"> ● Extended periods of idling and/or low-speed operation ● Frequent short trips (less than 7 miles = 11 km) ● Extended periods of driving in dusty and/or sandy areas ● Trailer towing ● Driving in mountainous areas 	<p>EVERY 6 MONTHS or 5,000 miles = 8,000 km WHICHEVER COMES FIRST</p>
<ul style="list-style-type: none"> ● Primarily highway driving ● Frequent trips of longer than 7 miles = 11 km ● Normal driving 	<p>EVERY 12 MONTHS or 10,000 miles = 16,000 km WHICHEVER COMES FIRST</p>

pg. 75 Cooling system

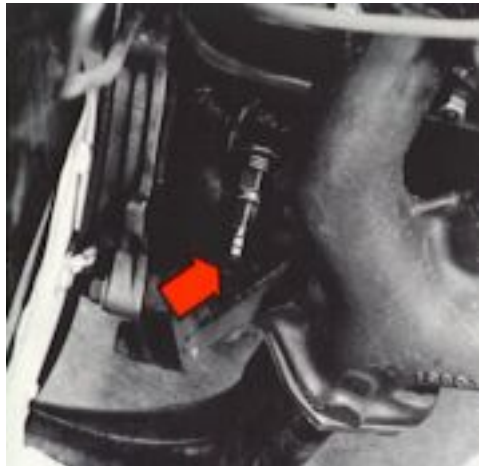

Changing coolant

Normally, the coolant does not need to be changed. If the system must be drained, use the following procedure: Remove the expansion tank cap. Open the drain cock on right side of the engine block and disconnect the lower radiator hose.

Fill coolant through the expansion tank.

The heater controls should be fully open when draining and filling.

Add coolant until the level is up to the MAX mark or slightly above.

Start engine and run until hot. Check the cooling system connections for tightness. Also re-check the coolant level. Capacity: 9.9 US qts. = 9.4 liters (manual transmission models); 9.7 US qts. = 9.2 liters (automatic transmission models) - Volvo Genuine Coolant/Anti-freeze.

Cooling system, hoses and connections

Check all cooling system hoses and connections for defects or deterioration of hoses and loose clamps or fittings.

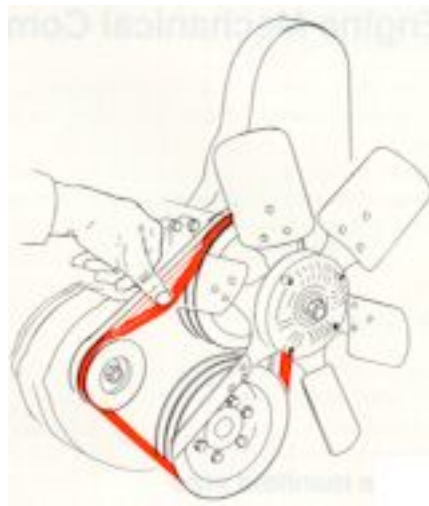

Drive belts

The belt tension can be checked by depressing the fan belt at a point midway between the generator and fan pulleys as illustrated. It should be possible to press down the belt about 1/4"-3/8" (5-10 mm). This also applies to other drive belts on the engine. If drive belts are replaced, recheck belt tension after driving 600-1,200 miles (1,000-2,000 km).

WARNING!

The engine must NOT be running when belt tension is checked.

pg. 76 Service requirements

Engine Mechanical Components

Torque manifold nuts

A loose manifold could alter air/fuel ratio and cause an increase in emission and/or poor driveability.

Valves

The valve clearance should be checked every 30,000 miles (48,000 km).

Exhaust Gas Recirculation (EGR)

This system operates by returning some of the exhaust gases to the engine to be recombusted: since this lowers the combustion temperature the amount of nitrogen oxides released into the atmosphere is reduced. The EGR valve should be inspected at the 60,000 mile (96,000 km) inspection and there-after cleaned every 20,000 miles (32,000 km). B 230 FD only : The EGR valve should be cleaned at 100,000 miles (160,000 km).

Pulsed Secondary Air Injection

(certain models)

This system adds air to the hot exhaust gases as they are expelled from the engine. This causes a secondary combustion of residual hydrocarbons and carbon monoxide, resulting in lower emission levels in the exhaust gases.



[Contents](#) | [Top of Page](#)

Engine Fuel System

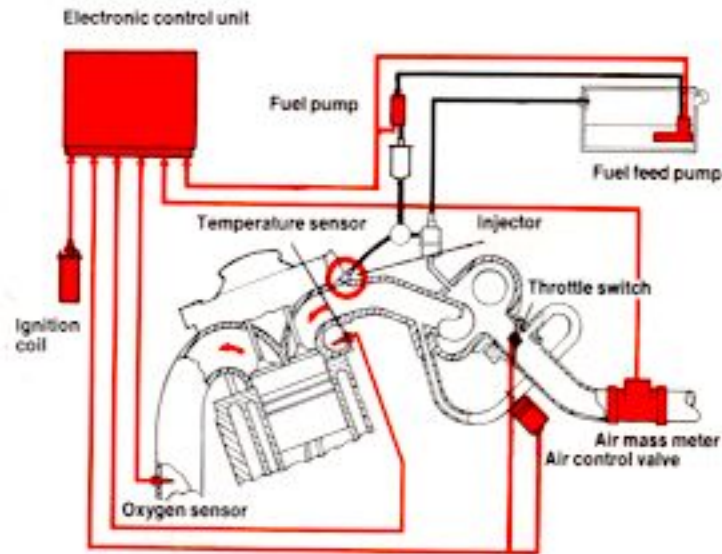

The fuel injection system is all-electronic and is microprocessor controlled. It can continually compensate for variations in engine load, speed and temperature to give the best economy and power. The most unique feature of the system is the mass air flow sensor which measures the mass of the inducted air instead of the volume. In this way the system can make instantaneous adjustments for changes in air temperature or density, thus always assuring the best economy with the lowest possible exhaust emissions.

Special instructions for work on the fuel injection system

Extreme cleanliness is essential when working on the injection system. Great care must be observed. Injection system service should be handled by qualified technicians, using equipment intended for this service.

Fuel (line) filter

We recommend that this filter be changed every 60,000 miles (96,000 km). The filter is replaced as one complete unit.

Replace more frequently if contaminated fuel was introduced into the tank.

For B 230 FD only: Replacement is recommended but not required to maintain Volvo Emission Warranty.

Fuel system cap, tank, lines and connections

The ability of the fuel system to control hydrocarbon emissions is dependent largely on a leak-free system. Check for proper sealing of gasoline filler cap which contains "O"-ring type seals. Check all evaporative hoses in vehicle for tightness. Check fuel lines under vehicle. Repair if necessary.

Timing gear belt

B 230 F

We recommend that the timing gear belt be replaced every 50,000 miles (80,000 km)

B 230 FD only: Replace the timing gear belt every 100,000 miles (160, 000km)

Air cleaner

Replace the air cleaner cartridge every 30,000 miles (48,000 km) The cartridge should be replaced more often when driving under dirty and/or dusty conditions.

The filter cannot be cleaned and should always be replaced with a new one.

Checking and adjusting idle speed

Your Volvo is equipped with an electronically controlled idle air control system that requires no periodic checking or adjustment.

Heated oxygen sensor system

This is an emission control system designed to reduce emissions and improve fuel economy. The heated oxygen sensor monitors the composition of the exhaust gases leaving the engine. The exhaust gas analysis is fed into an electronic module which continuously influences the amount of fuel injected. This adjusts the air-fuel ratio to provide optimum conditions for combustion and efficient reduction of the three major pollutants (hydrocarbons, carbon monoxide, and nitrogen oxides) through a three-way catalytic converter.

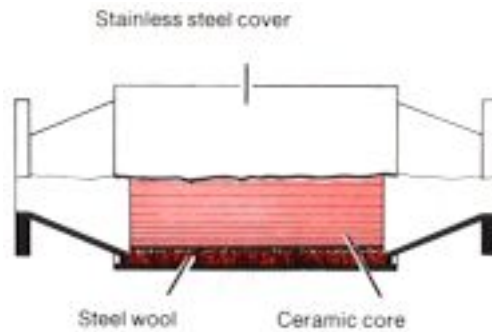

Heated Oxygen Sensor

On the B230F engines, the oxygen sensor is electrically heated. The use of a PTC (Positive Temperature Coefficient) element to heat the oxygen sensor ensures a shorter warm up time and continuous operation at its working temperature.

The heated oxygen sensor does not require periodic replacement.

Three Way Catalytic Converter

This is a supplementary device in the exhaust system, designed to reduce exhaust emissions. This device is mainly a container with a ceramic material insert, designed to let exhaust gases pass through channels in the insert. The channel walls are covered by a thin layer of platinum and rhodium. These metals act as catalysts, permitting a chemical action to occur without actually taking part in it. The carbon monoxide content will increase if the Three Way Catalytic Converter is damaged.

CAUTION:

Vehicles with Three Way Catalytic Converter must use unleaded fuel only. Otherwise the Three Way Catalytic Converter will become damaged and ineffective.

pg. 80 Servicing (cont.)

Engine Crankcase Ventilation system

Crankcase ventilation

The engine is provided with positive crankcase ventilation (PCV) which prevents crankcase gases from being released into the atmosphere.

Instead, the crankcase gases are admitted to the intake manifold and cylinders.



- B230F
1. PCV nipple
 2. Flame Guard
 3. Oil trap

PCV system, B230F engine

The PCV nipple in the intake manifold should be cleaned after 60,000 miles (96,000 km).

pg. 81 Servicing (cont.)

Engine Evaporative Emissions

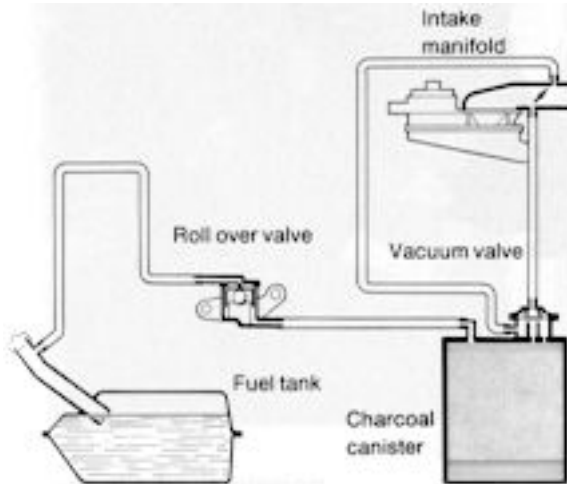

Evaporative control systems

Vehicles intended for the North American market are equipped with a fuel vapor evaporative control system, which prevents gasoline fumes from being released into the atmosphere. The system is comprised of an expansion chamber in the fuel tank, a roll-over valve and the cross member in front of the fuel tank, and a charcoal canister with built-in vacuum valve. The components are interconnected by hoses which channel fuel vapor from the gas tank to the charcoal filter where they are stored until the engine is started and then drawn into the engine fuel induction system.

Engine Ignition

Change spark plugs

The spark plugs should be changed every 30,000 miles (48,000 km).

However, prolonged city driving or fast highway driving may necessitate changing spark plugs after 15,000 miles (24,000 km) of driving. When installing new plugs, be sure to fit the right type and use the correct torque, see "Specifications".

When changing the spark plugs, check that the suppressor connectors are in good condition. Cracked or damaged connectors should be replaced.

When changing spark plugs, clean the cables and cable terminals, also the rubber seals.

CAUTION: Do not use silicone-based lubricants, which can have adverse effects on electrical components.

WARNING!

The ignition system operates at very high voltages. Special safety precautions must be followed to prevent injury:

Always turn the ignition off when:

- connecting engine test and diagnostic equipment to the vehicle (timing light, tach-dwell tester, ignition oscilloscope, etc.)
- Replacing ignition components e.g. plugs, coil, distributor, high-tension leads etc.



[Contents](#) | [Top of Page](#)

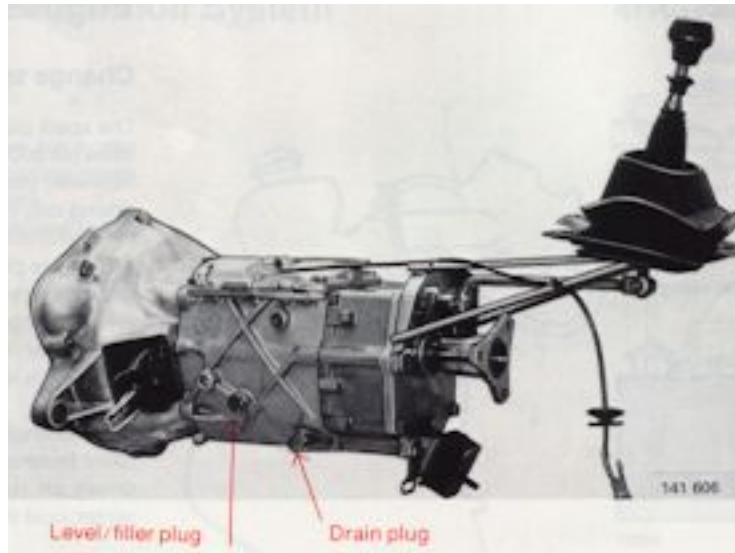

Manual transmission with overdrive, M47 II

Capacity: 1.6 US qts 1.5 liters.

Fluid type: Automatic Transmission Fluid Type F

The oil level should be up to the level/filler plug.

When replacing transmission oil, drain the oil immediately after driving, while it is still hot, by removing the drain plug.

Warning: Use care to prevent possible burning from hot transmission oil.

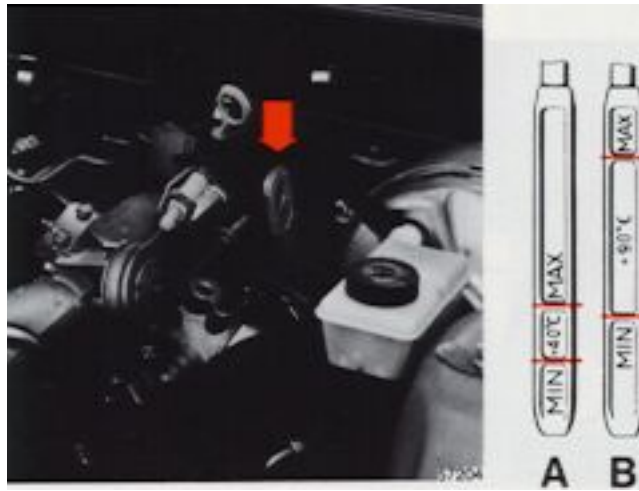

Automatic transmission

Capacity: 7.8 US qts (7.4 liters)

Fluid type: Automatic Transmission Fluid type Dexron II D.

Replace: every 20,000 miles (32,000 km).

A Cold transmission: oil temperature = + 105°F (+ 40°C) .

This is a normal temperature for the transmission after idling for about 10 minutes.

At oil temperature below +105°F (+40°C), the level may be below the MIN mark.

B Warm transmission: oil temperature = + 195°F (+ 90°C) .

This temperature is obtained when driving for about 30 minutes.

At oil temperature above + 195°F (+ 90°C), the level may be above the MAX mark.

Note!

The engine should be idling when checking transmission fluid level.

Check the oil level as follows:

Park the car on level surface with the engine idling.

Slowly move the selector lever through all the gear positions and then to position P. Wait 2 minutes before checking the oil level. As the illustration shows, the dipstick has a "Cold" and a "warm" side.

The oil level should be between the MIN and MAX marks.

Wipe the dipstick with a clean cloth.

WARNING! The oil may be very hot!

Do not use rags which can leave lint on the dipstick.

The transmission is topped up via the dipstick tube.

The space between the MIN and MAX marks on the dipstick corresponds to 0.5 US qts (0.5 liter). Do not fill the transmission with too much oil, since this can result in oil being ejected from the transmission.

Too little oil, on the other hand, can negatively affect transmission operation, particularly in very cold weather.

pg. 84 Power steering fluid, Brake fluid



Power steering fluid

Capacity: 0.8 US qts = 0.75 liters

Fluid type: ATF

Replace: no fluid change required.

The dipstick is attached to the cap. Fluid level should be between MIN and MAX marks. Add fluid when the level is at the ADD mark.

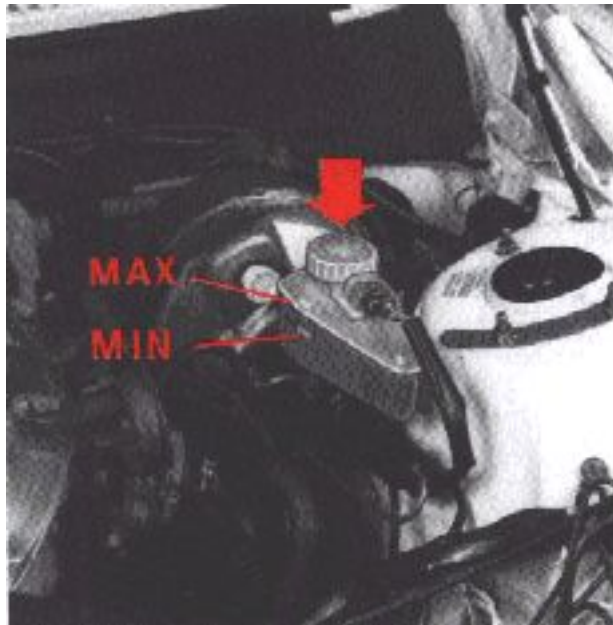

Brake fluid

Fluid type: DOT 4

Replace: every 2 years or 30,000 miles (48,000 km).

Check, without removing the cap, that the level is above the "MIN" mark of the fluid reservoir.

Always entrust brake fluid changing to a Volvo dealer.

Change brake fluid every year when driving under extremely hard conditions (mountain driving etc.) and if the car is equipped with a non factory air dam.

pg. 85 Body Lubrication



Chassis maintenance

To simplify maintenance, your Volvo has been equipped with ball joints steering rods and propeller shafts that do not require regular lubrication.

Points that normally require lubricating have been packed with very durable grease at the factory and then carefully sealed, eliminating the need for subsequent lubrication.

Lubricate body

To avoid rattles and unnecessary wear, the body should be lubricated once a year. Hinges on hood, doors and trunk lid as well as door stops should be lubricated every 10,000 miles (16,000 km).



Door hinges (lower) and door stop

A grease B oil

No. Lubricating point Lubricant

- 1 Trunk lid lock keyhole Low temperature grease
- 2 Trunk lid hinges Oil
- 3 Door lock keyhole
outer sliding surfaces Oil
- 4 Sunroof wind deflector Oil
- 5 Hood hinges Oil
- 6 Hood lock Oil
- 7 Front seat slide rails
and latch devices Oil
- 8 Window regulator Oil, grease
Locking device Silicon grease
(Accessible after door
upholstery panels
removed)
- 9 Door hinges Grease
Door stop Oil



Check coolant level

The cooling system must be filled with coolant and not leak to operate at maximum efficiency. Check the coolant level whenever you refuel. The level should be between the "Max" and "Min" marks on the expansion tank. The check should be made with particular thoroughness when the engine is new or the cooling system has been drained.

Do not remove the filler cap other than for topping up with coolant. Frequent removal may prevent coolant circulation between the engine and the expansion tank during engine warm up and cooling.

If you change the coolant yourself, you should ensure that the used coolant is disposed of in a manner which does not pose an environmental hazard. Allow your Volvo dealer to help you in disposing of the used coolant in an environmentally safe way.

CAUTION

The cooling system must always be kept filled to the correct level.

If it is not kept filled, there can be high local temperatures in the engine which could result in damage.

Different types of anti-freeze may not be mixed.

Top up with coolant

Top up with coolant by filling the expansion tank when level is at the "Min" mark. Use a mixture of 50 percent Volvo Type C coolant and 50 percent water all the year round. Top up to the "Max" mark.

If the engine is warm, and you are going to add coolant, unscrew the cap slowly in order to allow any excess pressure to escape.

Note: Do not add water only. Water by itself reduces the rust protective and anti-freeze qualities of the coolant and has a lower boiling point. It can also cause damage to the cooling system if it should freeze.

See 'Specifications' section of the manual for type of coolant recommended.

Cooling system

The risk of overheating is greatest, especially in hot weather, when:

- towing a trailer up steep inclines for prolonged periods at full throttle, and at low engine rpm.
- idling for prolonged periods while the air conditioning system is in operation.
- stopping the engine suddenly after high speed driving, so called after-boiling.

To avoid overheating, the following rules should be followed.

- Reduce speed and downshift when towing a trailer up long steep inclines. The risk of over heating can be reduced by switching off the air conditioning system for a short while.
- Do not let the engine idle unnecessarily.
- Do not stop the engine immediately after high-speed driving, but allow the engine to idle for 1/2 - 1 minute before switching off.

When the risk of overheating is imminent, or in the event of overheating, (the temperature gauge goes repeatedly into, or stays continually in, the red section) the following precautions should be taken:

- Switch off the air conditioning system and switch the heater to full (maximum) position.
- Stop the car and put the gear lever into neutral position-position N. Do not stop the engine!
- Increase the engine speed to approx. 2000 rpm (twice idling speed).
- Check the level of coolant in the expansion tank. Top-up, if necessary

pg. 87 Generator, Jump starting

Electrical System cautions

When changing the battery or when carrying out work involving the electrical system, the following should be observed:

- 1 A battery connection to the wrong terminal will damage the diodes. Before connections are made, check the polarity of the battery with a voltmeter.
- 2 If booster batteries are used for starting, they must be properly connected to prevent the diodes from being damaged. For correct connection, see "Jump starting".
- 3 The battery leads should be disconnected any time the battery is being charged.
- 4 Never disconnect the battery circuit (for example, to change the battery) while the engine is running,

as this will immediately ruin the alternator. Always make sure that all the battery connections are cleaned and properly tightened.

5 If any electrical welding work is performed on the vehicle, the ground lead and all the connecting cables of the alternator must be disconnected and the welder wires placed as near the welding point as possible.

WARNING!

The supplemental Restraint System is grounded under the driver's seat. Do not loosen the two screws grounding the unit. Do not ground other electrical components using these screws or any other points near them. Faults in the system could occur if it is improperly grounded.

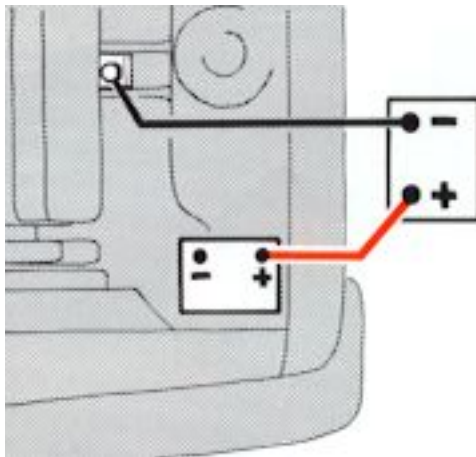

Jump starting

CAUTION: Improper hook-up of jumper cables or the use of other than 12 volt batteries could result in damage to equipment and/or battery.

Check that cars are not touching to prevent premature completion of negative circuit. Note the position of the battery terminals. When using jumper cables, first connect booster battery positive (+) terminal to car battery positive (+) terminal. Then connect booster battery negative (-) terminal to a stationary solid metal part on the engine at a point away from the battery. Do not connect booster cable to any part of fuel system or any moving parts. Avoid touching hot manifolds.

WARNING!

To prevent possible explosion, never expose battery to open flame or electric spark. Do not smoke near battery. Batteries generate hydrogen gas which is flammable and explosive.

Battery fluid contains sulfuric acid which can cause serious injury.

Do not allow battery acid to contact eyes, skin, fabrics or painted surfaces. If contact occurs, thoroughly flush affected area immediately with water.

Obtain medical attention immediately if eyes are affected.

After engine has started first remove negative (-) jumper cable, then positive (+) terminal jumper cable.

WARNING!

Failure to follow the instructions for jump starting can lead to personal injury.



[Contents](#) | [Top of Page](#)

Replacing bulbs

The replacement of bulbs in the various lighting units is shown on the following pages. Make sure when installing bulbs, that the guide pin on the socket fits into its corresponding recess.

When installing bulbs, do not touch the glass with your fingers. The reason for this is that grease, oil or any other impurities can be carbonized onto the bulb and damage the reflector.

Use bulbs of correct type and voltage. Failure to do so could activate the bulb failure warning light.

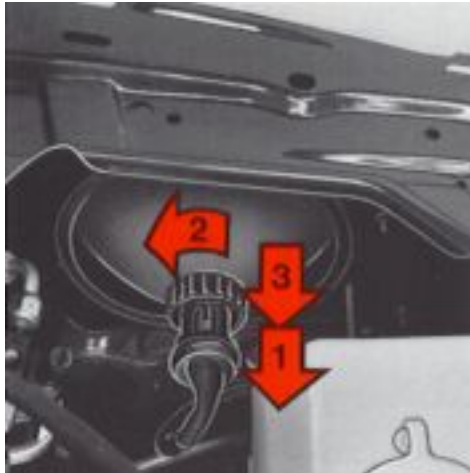

Replacing headlight bulbs

Working inside the engine compartment, separate the socket contact from the bulb holder (1). Unscrew and remove the bulb holder retaining ring (2) Pull out the bulb holder assembly, and replace it as a unit (3).

Installation is the reverse of removal.

Check headlight alignment.

Bulb Power Trade No.
Headlamp 45/65W 9004



Front light bulbs

Loosen the Phillips screws and remove the lens. The bulbs can now be removed by pressing them inwards and turning them slightly counterclockwise.

When re-installing lens, check that the gasket is in position.

Bulbs Power Socket

CP(W)

1 Front position 24/2.2(21/5) BaY15d

Side marker lights

2 Front turn signal 24/2.2(21/5) BaY15d 1) US Bulb No. 1157NA

pg. 89 Replacing bulbs

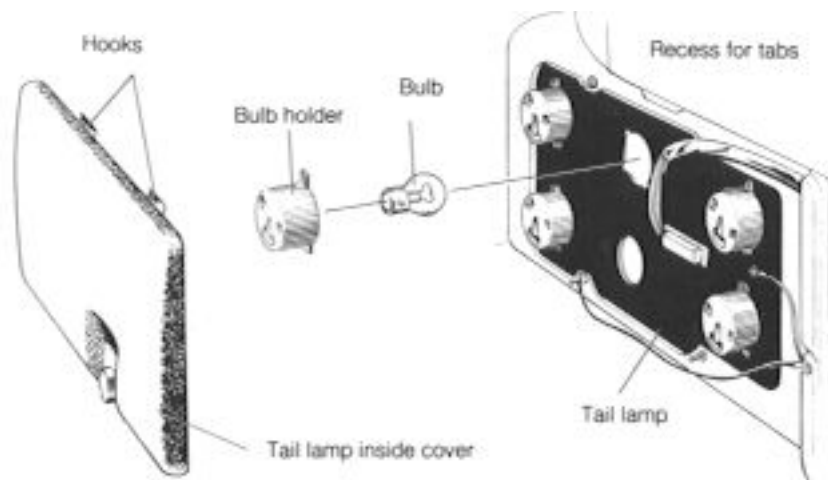

Tail lamp bulbs, sedan model

All tail lamp bulbs are replaced from inside of trunk.

1 Unscrew and remove tail lamp inside cover. Note that inside cover is hooked at the upper edge. Lift

the lower end out up and unhook upper edge.

2 Turn bulb holder approx 3,8" (1 cm) counterclockwise and remove it.

3 Depress bulb n bulb holder turn it slightly counterclockwise and remove it.

4 Install a new bulb Install bulb holder in tail lamp.

NOTE: One of the bulb holder tabs is wider and fits only in corresponding recess.

Turn bulb holder clockwise. Check that bulb lights Replace tail lamp inside cover.



Power

Bulbs	Power			US Bulb No
	CP	W	Socket	
1 Rear fog light	32	21	Ba 15s	1156
2 Back-up light	32	21	Ba 15s	1156
3 Rear turn signal	32	21	Ba 15s	1156
4 Tail light	4	5	Ba 15s	67
5 Reflector	-	-	-	-
6 Brake light/tail light*	32/3	21/5	BaY 15d	1157

*Right side lamp holders are white. Left side lamp holders are black.



Tail lamp bulbs, wagon model

All bulbs in the tail light cluster are removed from the inside.

Changing bulb, left hand side:

- Remove the spare tire cover and the spare wheel.

Changing bulb, right hand side:

- Remove the right hand stowage cover.
- Loosen the clip and move panel aside (see illustration).

The procedure for changing a bulb is basically the same as for other models.

When re-installing, hold the bulb holder with the word "Volvo" turned towards the center of the car.

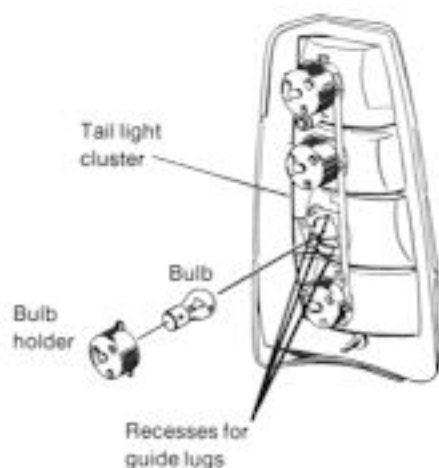

Bulbs	Power			US Bulb No
	CP	W	Socket	
1 Rear fog light	32	21	Ba 15s	1156

2 Back-up light	32	21	Ba 15s	1156
3 Rear turn signal	32	21	Ba 15s	1156
4 Brake light/tail light	32/3	21/5	BaY 15d	1157

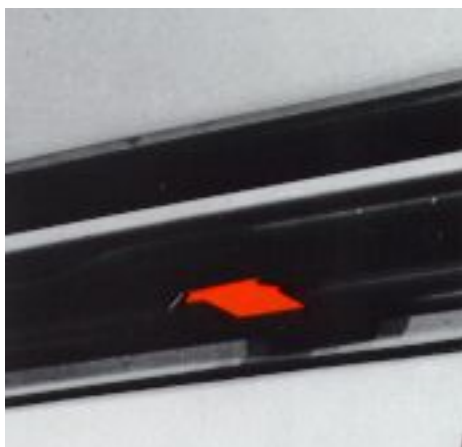

License plate light, sedan model

Slide the bulb housing backwards until it is released from the front edge. Pull out the lamp housing and replace the bulb. Insert the front edge of the lamp housing and press up the rear edge by hand.

Bulbs Power Socket

License plate light, 4 W Ba 9 s
sedan model

pg. 91 Replacing bulbs

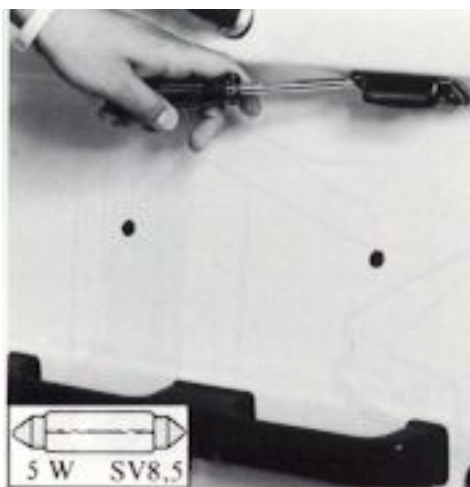

License plate light, wagon model

Insert a screwdriver through the opening in the housing and depress the catch tab.
Pull out the housing assembly.

Bulbs Power Socket

License plate light, 5 W S 8.5 - 8 wagon

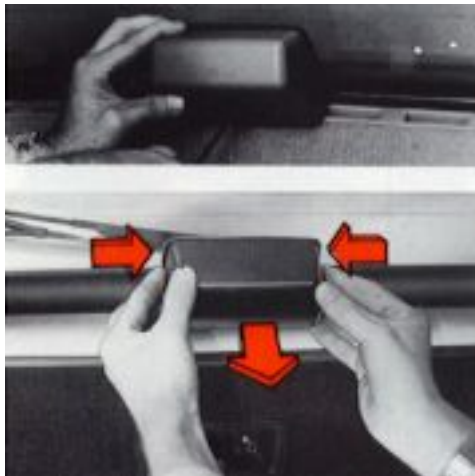

High-mounted stop light

On sedans (top), use screwdriver to depress catch then pull plastic cover up and away from the light assembly.

On wagons (bottom). depress the marked areas on the side of the housing and pull it away from the light assembly.

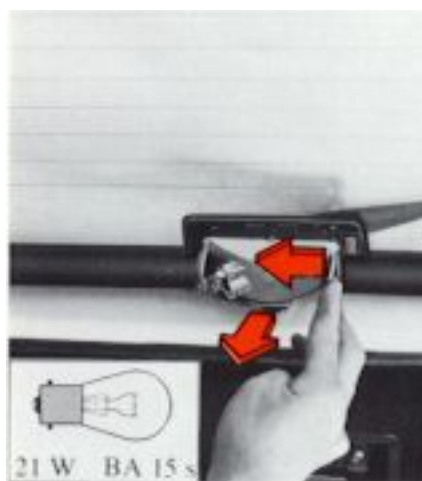

Press in reflector catch to release reflector assembly. Swing out reflector and replace bulb.
Snap reflector in and check that bulb lights when brake pedal is depressed.
Align the light assembly catches with the holes in the lamp housing and press it into place.

Bulbs Power Socket US Bulb No

High mounted 32 cp/ 21 W Ba 15 s 1156
stop light

pg. 92 Replacing bulbs

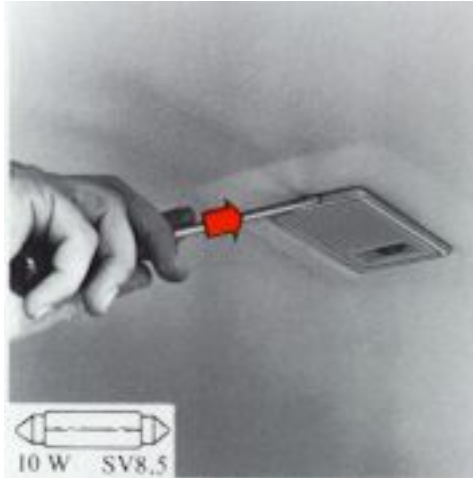

Interior light

Insert a screwdriver through the opening in the right side of the housing and depress the catch tab. Pull out the housing assembly and replace the bulb.

Bulb Power Socket

Interior light 10 W S 8.5 - 8



15 W SV8,5

Trunk light

Remove screw holding the light assembly Lift it out to remove.

Replace the bulb.

Reinstall by first inserting the guides into one side, then press in, the light assembly and install the screw.

Bulb Power Socket

Trunk light 15 W S 8.5 - 8

Instrument and heater control lighting

Due to the location of these bulbs their replacement should be carried out by a Volvo dealer.

pg. 93 Fuses

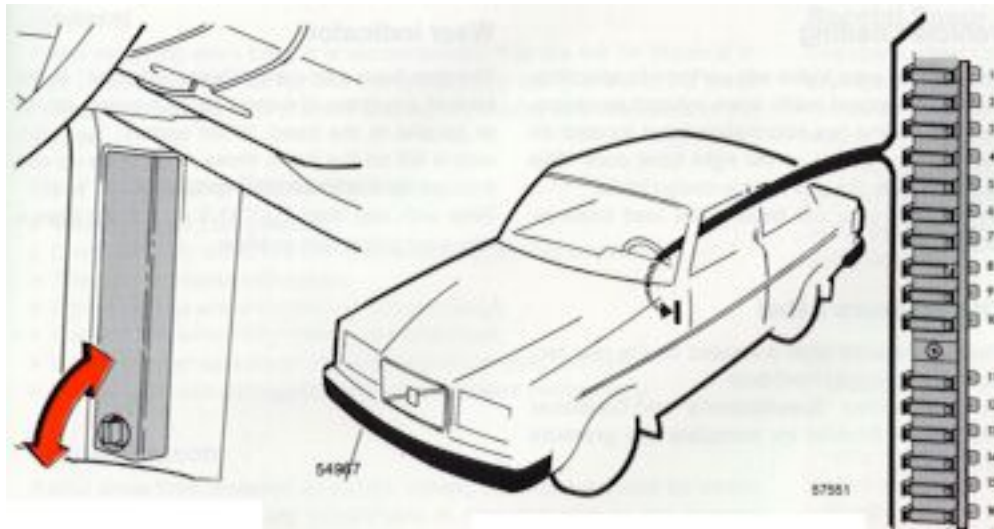

Replacing fuses

The fuse box is positioned in front of the left front door pillar. When replacing fuses, check that the correct amperage is used.

Never use fuses of higher amperage. unless specified by your Volvo dealer. If one fuse repeatedly fails, take the car to your Volvo dealer for fault tracing.

A spare fuse kit is available from your Volvo dealer.

Warning: Turn starting (ignition) switch OFF before replacing fuses. Excessive heat may be created by a short circuit. Care must be exercised while replacing blown fuses.

Some of the equipment listed below is optional

Refer to the fuse location chart at fuse box for fuses specific to your car.

1 Cigarette lighter, Power mirrors, Radio, Tailgate wiper/washer 8A

2 Windshield wiper/washer, Horn 16A

- 3 Heater blower 25A
- 4 Fuel feed (in-tank) pump, HO2S heating element 8A
- 5 Turn signals, Tail lights, Heated mirrors 16A
- 6
- 7 Brake lights, Shiftlock, ABS 8A
- 8 Central locking, Interior and glove compartment lights, Trunk compartment lights, Radio, Power antenna, Clock, Daytime running lights (Canada) 8A
- 9 Hazard warning Flashers 8A
- 10 Power windows 16A
- 11 Heated rear window, 4th gear (automatic transmission) 16A
- 12 Air conditioning (with blower control), Power windows (relay), Heated rear window (relay), Seat belt reminder, Cruise control, Shiftlock 8A
- 13 Heated front seats, Daytime running lights - relay (Canada) 16A
- 14 Rear fog lights 8A
- 15 Parking lights (left side), License plate light 8A
- 16 Parking lights (right side), Instruments and control panel lights, Shift indicator light 8A

ABS-equipped vehicles: this system is protected by a separate 10A fuse located under the seat on the passenger's side.



[Contents](#) | [Top of Page](#)

Checking and correcting tire pressure

Check the tire pressure when refueling. The tire pressure should only be corrected when the tires are cold. With warm tires, correct only when the pressure is too low. The tire temperature (and, thus, pressure) rises after driving just a few miles.

Warning: Improperly inflated tires will reduce tire life, adversely affect vehicle handling and can possibly lead to failure resulting in loss of vehicle control without prior warning.

Roadholding

Vehicle load, tire design and inflation pressure are important for proper handling. Therefore check that the tires are inflated to the recommended pressure according to the vehicle load. Loads should be distributed so that capacity weight or maximum permissible loads are not exceeded. It is recommended to use tires of the same make and dimensions on all four wheels.

Warning: Do not mix radial and bias ply tires as this will adversely alter the vehicle handling characteristics.

Vehicle Loading

The tires on your Volvo will perform to specifications at all normal loads when inflated as recommended on the tire information label located on the rear facing side of the right front door. This label lists both tire and vehicle design limits. Do not load your car beyond the load limits indicated.

Tire Pressure Label

The tire pressure label is located on the rear facing side of the right front door. See section titled "Specifications" and Consumer Information Booklet for complete tire pressure information.

Wear indicator

The tires have a so-called "wear indicator in the form of a number of narrow strips running across or parallel to the tread. When approx 1/16 " (1.5 mm) is left on the tread, these strips show up and indicate the tire should be replaced.

Tires with less than 1/16" (1.5 mm) tread have a very poor grip in rain or snow.

VEHICLE CAPACITY		OCCUPANTS			COLD TIRE PRESSURE	
WEIGHT		FRT	RR	TOTAL	FRONT	REAR
MAX LOAD		2	3	5		PSI
RECOMMENDED FOR FUEL ECONOMY						
OPTIONAL PRESSURE						
TIRE SIZE		2	1	3		PSI
<small>IF TUBES ARE NOT FROM BENTON AND WPI (28 WPI) TO THESE RECOMMENDED PRESSURES</small>						
	SIZE	SPARE TIRE	INFLATION		PSI	
SEE OWNER'S MANUAL FOR ADDITIONAL INFORMATION						
VOLVO						
1338148						

Snow chains

Snow chains can be used on your Volvo with the following restrictions:

- Snow chains should be installed on rear wheels only.
- Snow chains can be used on the tires and wheels provided as original production equipment with your Volvo.
- If accessory, aftermarket or "custom" tires and wheels are installed and are of a size different than the original tires and wheels, chains in some cases cannot be used. Sufficient clearances between chains and brakes, suspension and body components must be maintained.
- Some strap-on type chains will interfere with brake components and therefore CANNOT be used.

Your Volvo dealer can provide Volvo accessory tire chains that can be installed on all Volvo original tires and wheels.

CAUTION:

- Check local regulations regarding the use of snow chains before installing.
- Always follow the chain manufacturer's installation instructions carefully. Install chains as tightly as possible and re-tighten periodically.
- Never exceed the chain manufacturer's specified maximum speed limit. (Under no circumstances should that limit be higher than 30 mph (45 km/h).
- Avoid bumps, holes or sharp turns when driving with snow chains.
- The handling of the vehicle can be adversely affected when driving with chains. Avoid fast or sharp turns as well as locked wheel braking.

General

When replacing worn tires, it is recommended that the tire be identical in type (radial) and size as the one being replaced. Using a tire of the same make (manufacturer) will prevent altering the driving characteristics of the vehicle.

How to improve tire economy

- Maintain correct tire pressure
- Drive smoothly: avoid fast starts, hard braking and tire screeching.
- Tire wear increases with speed
- Do not change wheel location unless necessary
- Correct front wheel alignment is very important
- Unbalanced wheels impair tire economy and driving comfort
- Hitting curbs can damage the tires and/or wheels permanently

Winter Season

Radial snow tires, installed on all four wheels, are recommended for winter driving Use tires that are comparable in size and type to the original equipment installed by the factory.

Mixing tires of different size, brand, or design could negatively affect tire road grip, especially when slippery road conditions exist.

Note: Overall diameter of tire and wheel combination will affect speedometer accuracy and fuel economy.

Special Spare

The spare wheel for your car is referred to as a "Special Spare". This name is embossed on the tire. Wheel rim size is 5 x 15".

Recommended tire pressures (see decal) should be maintained irrespective of which position on the car the Special Spare tire is used on.

In the event of a damage to this tire a new one can be purchased from your Volvo dealer.

WARNING!

Current legislation prohibits the use of this tire other than as a temporary replacement for a punctured tire. In other words, it must be replaced as soon as possible by a standard tire. Roadholding, etc., might be affected with the "Special Spare" in use. Do not exceed 50 mph (80 km/h).

WARNING!

Special wheel rims

Only special wheel rims, tested and approved by Volvo, are suitable for use with the factory-installed air dam. Any other wheel rims may not permit sufficient air circulation for brake cooling.

pg. 96 Wheel changing

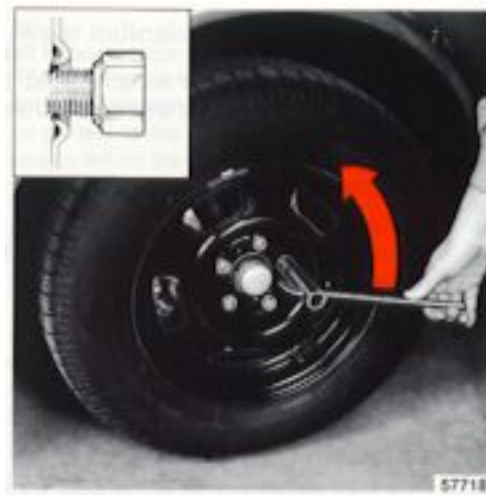

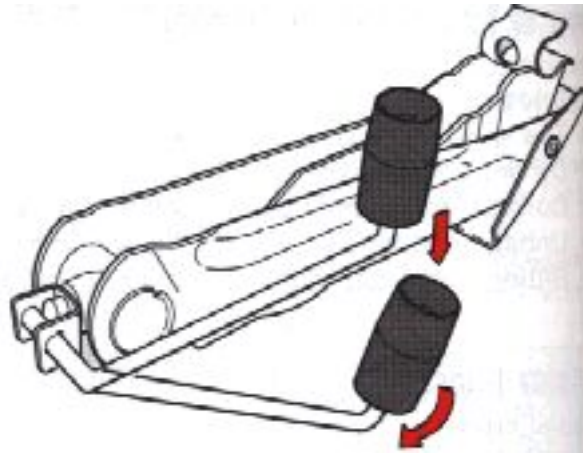

Changing a wheel

Spare wheel, jack and tool kit are stowed in the trunk compartment. Make sure that the spare wheel is secured. On the wagon models the jack and crank should be secured according to the above illustration to avoid any disturbing rattle. Before raising the car with the jack be sure it is on firm and level ground.

Warning: Do not crawl or work under the car while it is raised by the jack.

Removal

Steel wheel: Grasp the wheel cover with both hands and pull off.

Alloy wheel: Pry the center emblem off with a screwdriver. The wheelcover can then be removed by hand.

Loosen the wheel nuts 1/2-1 turn with the box wrench provided in the tool kit. All of the wheel nuts have right hand threads which are loosened by turning them counterclockwise.

Installation

Clean the contact surfaces on the wheel and hub. Lift the wheel and place it on the hub. Make sure that you align the wheel with the guide stud on the wheel hub prior to installation. Install the wheel nuts clockwise and tighten lightly. The bevelled side of each nut should face the wheel. Lower the vehicle to the ground and alternately torque the nuts to 63 ft. lbs. (85 Nm).

Install the wheel cap.

NOTE: The jack in your car comes in two versions. If your car is equipped with the alternate version (see illustration), the crank handle can be folded out by pressing the knob on the handle downward. To attach the jack, refer to the illustration on the following page.

To avoid excessive tire wear and rebalancing, mark and reinstall wheels in same location and position as before removal. To lessen the chance of imbalance, each wheel hub is equipped with a guide stud to ensure that a removed wheel can be reinstalled in its original position.

pg. 97 Wheel changing



Using the jack

There is a jack attachment adjacent to each wheel location. Hang the jack from the attachment (alt. 1) or position the jack on the bar in the jack attachment (alt. 2) as shown in the illustrations above the crank handle while simultaneously guiding the the base to the ground. The bas of the jack must be flat on a level, firm, non-slippery surface. Before raising the car check that the jack is still correctly positioned in the attachment. Now raise the vehicle until the wheel is free of the ground. Unscrew the wheel nuts completely and carefully remove the wheel so as not to damage the thread of the studs.

WARNING!

- The jack's hook must engage the pin in the jack attachment (A). The car's weight must not rest on the jack's hook (B).
- Never crawl under a car supported by a jack.
- Use the jack intended for the car when replacing a wheel.

For any other job use stands to support the end of the car being worked on.

- Apply the parking brake, engage first or reverse gear (pos. P for cars equipped with automatic transmission).
- Block the wheels standing on the ground. Use rigid wooden blocks or large stones.
- The jack should stand on firm, level ground.
- The jack should be kept well-greased.
- Do not rotate a raised rear wheel if the car is equipped with a limited slip differential. This will also rotate the opposite wheel (on the ground) and the car may slide off the jack.



[Contents](#) | [Top of Page](#)

Replacing wiper blades



Lift the wiper arm off the windshield and hold blade at right angles to arm. Pinch the end of the plastic clip located at the back of the arm.



Slide the wiper blade along the arm to release it from the hook.



Install new blade in reverse order to removing and make sure that it is properly attached to the wiper arm.

For reasons of safety, you should change the windshield wiper blades as soon as they start to leave marks on the windshield or fail to wipe efficiently and cleanly.

To obtain maximum lifetime from a set of wiper blades, clean them with a stiff-bristle brush and warm, soapy water as part of a normal car wash.

Washing

The car should be washed at regular intervals since dirt, dust, insects and tar spots adhere to the paint and may cause damage.

When washing the car, do not expose it to direct sunlight. Use lukewarm water to soften the dirt before you wash with a sponge, and plenty of water, to avoid scratching.

A detergent can be used to facilitate the softening of dirt and oil. Special car washing detergent or household detergent can be used. A suitable mixture is about 2.5 fl. oz. (8.5 cl) of detergent to 2.6 US gal. = 10 liters of warm water. After washing with a detergent the car should be well rinsed with clean water.

A water soluble grease solvent may be used in cases of sticky dirt. However, use a washplace equipped with a drainage separator.

Dry the car with a clean chamois and remember to clean the drain holes in the doors and rocker panels.

Tar spots can be removed with kerosene or tar remover after the car has been washed.

Power radio antenna (optional) must be dried after washing.

During high pressure washing the spray mouthpiece must never be closer to the vehicle than 10 cm. Do not spray into locks.

CAUTION: It is particularly important to wash the car frequently in the winter time, to prevent corrosion, when salt has been used on the roads. Also wash off the dirt on the underside (Wheel housings and fenders etc.)

WARNING: When the car is driven immediately after being washed, carefully apply the brakes several times in order to remove any moisture from the brake linings.
Engine cleaning agents should not be used when the engine is warm. This constitutes a fire risk.

pg. 99 Washing, Cleaning, Anti-rust treatment

Automatic washing - simple and quick

An automatic wash is a simple and quick way to clean your car, but it is worth remembering that it can never be as thorough as when you yourself go over the car with sponge and water. Keeping the underbody clean is most important, especially in the winter. Some automatic washers do not have facilities for washing the underbody.

Before driving into an automatic wash, make sure that side view mirrors, auxiliary lamps, etc., are secure, otherwise there is risk of the machine dislodging them. You should also lower the antenna. During high pressure washing the spray mouthpiece must never be closer to the vehicle than 13" (30 cm). Do not spray into the locks.

Bird droppings /Tree sap

Remove from paintwork as soon as possible. Otherwise the finish may be permanently damaged.

Chromed parts

Chromium-plated and anodized parts should be washed with clean water as soon as they become dirty. This is particularly important if you drive on gravel roads or on roads where salt is used during the winter. After the car has been washed, apply wax or an anti-rust preparation. Stains on chrome trim can be removed with commercially available chrome cleaner. Do not use abrasive compounds or steel wool.

Polishing (waxing)

Normally, polishing is not required during the first year after delivery. Waxing may be beneficial. Before applying polish or wax the car must be washed and dried. Tar spots can be removed with kerosene or tar remover. Difficult spots may require a fine rubbing compound. After polishing use liquid or paste wax.

Several commercially available products contain both polish and wax. Waxing alone does not substitute for polishing of a dull surface.

A wide range of polymer based car waxes can be purchased today. The waxes are easy to use and produce a long lasting high gloss finish which protects the bodywork against oxidation, road dirt and fading.

Cleaning the upholstery

The fabric can be cleaned with soapy water or a detergent. For more difficult spots caused by oil, ice cream, shoe polish, grease, etc., use a stain remover.

The plastic in the upholstery can be washed with soapy water or a mild detergent.

Leather upholstery can be cleaned with a soft cloth and mild soap solution.

For more difficult spots, consult your Volvo dealer.

On no account must gasoline, naphtha or similar cleaning agents be used on the plastic or upholstery since these can cause damage.

When aging, leather changes appearance, but the typical texture remains. To preserve smoothness and appearance, it is recommended to treat the leather with a special leather preservative after one or two years of use.

Cleaning the seat belts

Clean only with luke warm water and mild soap solution.

CAUTION: Do not use cleaning solvents to clean the seat belts.

Cleaning floor mats

The floor mats should be vacuumed or brushed clean regularly, especially during the winter when they should be taken out for drying.

Spots on textile mats can be removed with a mild detergent.

Anti-rust treatment

Your Volvo has been rust protected at the factory. On external surfaces a heavy coat of wear resistant material has been used, while on the internal surfaces a lighter rust inhibitor is used.

As part of your maintenance schedule, the rust protection should be inspected regularly by your authorized Volvo dealer. Consult the Volvo Protection Limited Warranty found in your Warranty Information Booklet for additional terms and conditions.

For further information, see section titled "What causes rust" or see your Volvo dealer.

pg. 100 Paint touch-up

Paint touch-up

Paint damage requires immediate attention to avoid rusting. Make it a habit to check the finish regularly, for instance when washing the car. Touch-up if necessary.

Paint repairs require special equipment and skill. Contact your Volvo dealer for any extensive damages.

Minor scratches can be repaired by using Volvo touch-up paint.

Note: When ordering touch-up paint from your Volvo dealer, use the paint code indicated on the service label. The label is located on the wheel housing in the engine compartment.

Minor stone chips and scratches

Material:

Primer-can

Paint-can or touch-up bottle

Brush

Masking tape

Note: When touching-up the car, it should be clean and dry. The surface temperature should be above 60 ° F (+15 ° C).

Scars on the surface

If the stone chip has not penetrated down to the metal and an undamaged layer of paint remains, the touch-up paint can be applied as soon as the spot has been cleaned.

Deep scars

If the stone chip has penetrated down to the metal, proceed as follows:

1 Place a strip of masking tape over the damaged surface. Pull the tape off so that any loose flakes of paint adhere to it.

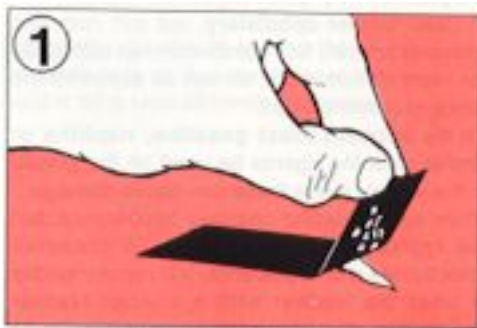

2 Thoroughly mix the primer and apply it with a small brush.



When the primer surface is dry, the paint can be applied using a brush. Mix the paint thoroughly, apply several thin paint coats and let dry after each application.

pg. 101 Paint touch-up

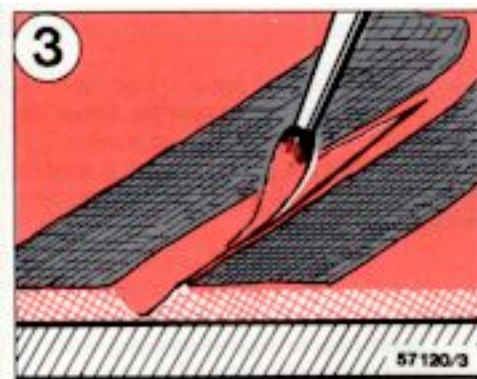

3 If there is a longer scratch, you may want to mask to protect surrounding paint.

Touching-up damaged paint on fender edges and sills

Material:

Primer-spray can

Paint-spray can

Masking tape

Note: When touching-up the car, it should be clean and dry. The surface temperature should be above 60 ° F (+15 ° C).

When large surfaces have to be repainted, suitably mask the surrounding area with masking tape and paper. Remove this masking as soon as the final coat has been sprayed on, before the paint dries.

1 Remove loose flakes of paint with masking tape. Shake the spray can for at least 1 minute. Spray the primer on.

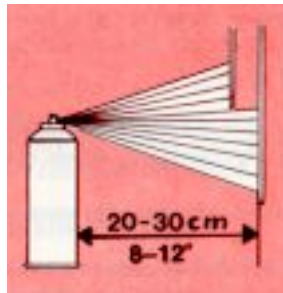

2 Move the spray can slowly and regularly from side to side, about 8-12 inches (20-30 cm) from the surface.

WARNING! Spray painting should be done in a well ventilated and dust-free area.

3 When the primer has dried, apply the surface enamel in the same way. Spray on several times and allow the paint to dry a minute or so between each application.

pg. 102 What causes rust

What causes rust

The two most common causes of rust to your car are:

1. The accumulation of road dirt and moisture in hard-to-get-at cavities and other areas under the car.
2. The removal of paint and protective coatings on the outside of the car and underneath through damage by stones, gravel or minor accidents.

Several factors influence the speed at which corrosion will occur:

1. The length of time various parts of a car stay wet. Parts of the car filled with road dirt and water remain damp for long periods of time even after other parts have dried.

Particular attention should be paid to the underside of the car and floor sections inside. The floor sections stay wet because moisture collects and remains under the floor matting.

Drain holes located at the bottom of the doors can get clogged with dirt, trapping water inside the door and causing the door to rust through at the bottom.

2. Corrosion will be accelerated in areas of higher relative humidity, especially where temperatures often stay above the freezing point and where the atmosphere is affected by industrial pollution, or where salt is used for de-icing the roads.

Where parts of the car are covered with road dirt containing road salt, corrosion will be accelerated at a lower relative humidity than if the surface were clean.

3. Increased temperature will cause an accelerated rate of corrosion of those parts of the car which are not well ventilated to permit quick drying.

4. Industrial pollution and the presence of salt will also accelerate the deterioration of paint finishes.

The foregoing underscores the need for every car owner to keep his or her car, particularly the underside, as clean and dry as possible. Repair any minor damage to paint work and protective coating as soon as possible. The need is more important in those localities where road salt is used for de-icing, the relative humidity is higher, air pollution is present and temperatures regularly stay above freezing.

pg. 103 Long distance trips, Cold weather

Prior to a long distance trip

Have your car checked at a Volvo dealer. Preventive maintenance will help to ensure a trouble free trip.

Remember to take along a Volvo dealer directory.

The main items to check are listed below:

1. Brakes, front wheel alignment and steering gear.
2. Engine running condition.
3. Fuel system operation.
- 4 Oil leaks: engine, transmission, rear axle.
5. Cooling system for leaks or worn hoses.
6. Examine tires carefully, replace worn tires.
7. Battery and terminals.
8. Tool equipment.
9. Lighting.
10. Drive belts, for tightness and wear.

11. All fluid levels.

Cold weather/Engine fuel system

During the winter, large variations in temperature cause condensation to form in the fuel tank and can impair the running of the engine. This can be reduced by adding dry gas to the fuel. There is less risk of condensation forming in the fuel tank if it is kept full or nearly full.

Engine cooling system

Volvo original coolant/anti-freeze coolant should be used all year round. The cooling system should always contain water plus anti-freeze and rust inhibitor, even during the summer. Experience has also shown that extremely weak anti-freeze solutions (10-25 percent) are ineffective for rust protection. For this reason, the quantity of antifreeze/summer coolant should be about 50 percent of the solution. This lowers the freezing point to - 30 ° F (-35 ° C). The use of "Recycled" Anti-freeze is not approved by Volvo.

Different types of coolant/anti-freeze may not be mixed.

Engine lubricating system

During the winter, multigrade oil 10W-30 should be used in the engine.

The viscosity of the engine oil is important. Oil with low viscosity (thinner oil) improves cold-weather starting as well as decreasing fuel consumption while the engine is warming up. To avoid difficult cold start conditions (during extreme winter weather), use of 5W-30 oil, particularly the synthetic type, is recommended.

Be sure to use good quality oil but do not use this cold-weather oil for hard driving or in warm weather. See section "Engine oil" for more information.

Doors

Use Volvo Teflon lock spray or grease in the locks.

Note: Avoid the use of de-icing sprays as they can cause damage to the locks.

Electrical system

The electrical system is subject to greater stresses during the winter. Lighting and starter motor are used more often. The battery capacity is reduced at low air temperature. The state of charge must be checked more frequently, and if necessary the battery should be recharged. The battery can freeze if the state of

charge is too low.

Windshield washers

Anti-freeze washer fluid should also be added to the washer fluid container for the windshield and rear window (tailgate, wagon model) washer.

This is particularly important during the winter because the windshield frequently becomes dirty and is often splashed with water which freezes rapidly. This may necessitate the frequent use of the windshield washer and wipers. Your Volvo dealer can supply you with suitable anti-freeze for this purpose. Suitable mixtures of anti-freeze and water are:

Down to +14 ° F (-10 ° C) 1 part anti-freeze 4 parts water.

Down to + 7 ° F (-14 ° C) 1 part anti-freeze 3 parts water.

Down to 0 ° F (-18 ° C) 1 part anti-freeze 2 parts water.

Down to -18 ° F (-28 ° C) 1 part anti-freeze 1 part water.



[Contents](#) | [Top of Page](#)